

MAC 250 / MAC 250⁺

user manual



Martin

section 1	
Safety	
Safety precautions	3
section 2	
Setup	
Unpacking	4
Lamp installation	4
Powering	5
Rigging	6
Connecting the serial data link	6
section 3	
Control Panel	
Menu navigation	8
Personality settings (PERS)	9
Address and protocol selection	10
Readouts (INFO)	10
Utilities (UTIL)	10
Test programs (TEST)	11
Manual control (MAN)	11
Adjustment (AdJ)	11
section 4	
Operation	
DMX-512 control	12
Martin RS-485 control	12
Controllable effects	12
section 5	
Basic Service	
Replacing the lamp	15
Optimizing reflector alignment	15
Rotating gobos	15
Changing color filters (MAC 250 ⁺ only)	16
Configuring the optical system (MAC 250 only)	17
Removing modules	18
Cleaning	18
Lubrication	18
Replacing fuses	19
Changing the XLR pin-out	19
Updating software	19
Changing voltage and frequency settings	20
section 6	
Appendixes	
DMX protocol	21
Error messages	24
Troubleshooting	25
PCB layout	26
Specifications	27

©1998 - 2000 Martin Professional A/S, Denmark.

All rights reserved. No part of this manual may be reproduced, in any form or by any means, without permission in writing from Martin Professional A/S, Denmark.

Printed in Denmark.

P/N 35000067, Rev. D

section 1 SAFETY

Thank you for selecting the Martin *MAC 250* or the *MAC 250⁺*. Both the *MAC 250* and the *MAC 250⁺* are yoke-mounted profile spotlights that are designed around a 250 watt discharge lamp. They provide:

- 12 saturated dichroic colors
- 8 replaceable rotating gobos
- 3-facet rotating prism
- variable focus
- strobe effects
- 0 to 100% dimming
- accurate 16-bit movement.

In addition, the standard *MAC 250* provides 4 user-configurable beam angles from 12.1° to 23.3°. The *MAC 250⁺* provides gobo indexing, interchangeable color filters, and an 18.3° achromatic lens system. High-performance optics, attractive design, modular construction and numerous user-friendly features make these Martin fixtures well suited for any effect lighting application calling for a compact, hard-focusing 250 watt fixture.

Safety precautions

The *MAC 250* and *MAC 250⁺* are for professional use only. They are not for household use. They present risks of injury due to electric shock, heat and ultraviolet radiation burns, lamp explosion, falls, high-intensity light, and fire. **Read this manual before powering or installing the fixture**, follow the safety precautions listed below and observe all warnings in this manual and printed on the fixture. If you have questions about how to operate the fixture safely, please contact your Martin dealer or call the Martin 24-hour service hotline for assistance.

- ALWAYS disconnect the fixture from AC power before removing or installing the lamp, fuses, or any part; and when not in use.
- Allow the fixture to cool for at least 5 minutes before replacing the lamp.
- Keep all combustible materials (for example fabric, wood, paper) at least 0.3 meters (12 inches) away from the fixture. Keep flammable materials well away from the fixture.
- For protection against dangerous electric shock, always ground (earth) the fixture electrically. Use only a source of AC power that complies with local building and electrical codes. Do not expose the fixture to rain or moisture.
- Ensure that the air flow through fans and vents is free and unobstructed.
- When suspending the fixture above ground level, verify that the structure can hold at least 10 times the weight of all installed devices and secure the fixture with an approved safety cable. Block access below the work area whenever installing or removing the fixture.
- Refer any service operation not described in this manual to a qualified technician.
- Do not illuminate surfaces within 0.3 meters (12 inches) of the fixture.
- Never place filters or other materials over the lens.
- Do not operate the fixture if the ambient temperature (T_a) exceeds 40° C (104° F).
- Replace the lamp as soon as it becomes defective or worn out, or before usage exceeds the maximum service life.
- Do not stare directly into the light.
- Never operate the fixture without all lenses and covers installed: an unshielded lamp can explode without warning and emits dangerous UV radiation that can cause burns and eye damage.
- Do not modify the fixture or install other than genuine Martin accessories and upgrade kits.

section 2 SETUP

Unpacking

The *MAC 250* and *MAC 250⁺* come with:

- 1 1/4-turn clamp mounting bracket
- 1 5-meter, 3-pin shielded XLR control cable
- 1 3-meter, 3-wire IEC power cable
- 1 user manual

The packing material is carefully designed to protect the fixture during shipment - always use it or a custom flight case to transport the fixture.

Lamp installation

Compatible lamps

The lamps listed in the table below may be used with the *MAC 250* and *MAC 250⁺*. *Installing any other lamp may damage the fixture.*

Lamp	Replace before	Average life	Color Temp.	Output	P/N
Osram HSD 250	2500 hr	2000 hr	6000K	68 lm/W	97010103
Philips MSD 250/2	2200 hr	2000 hr	6500K	72 lm/W	97010100
Philips MSD 200	2200 hr	2000 hr	5600K	67 lm/W	97010106

WARNING!

Disconnect the fixture from AC power and allow the lamp to cool for at least 5 minutes before proceeding. Wear safety goggles to protect your eyes.

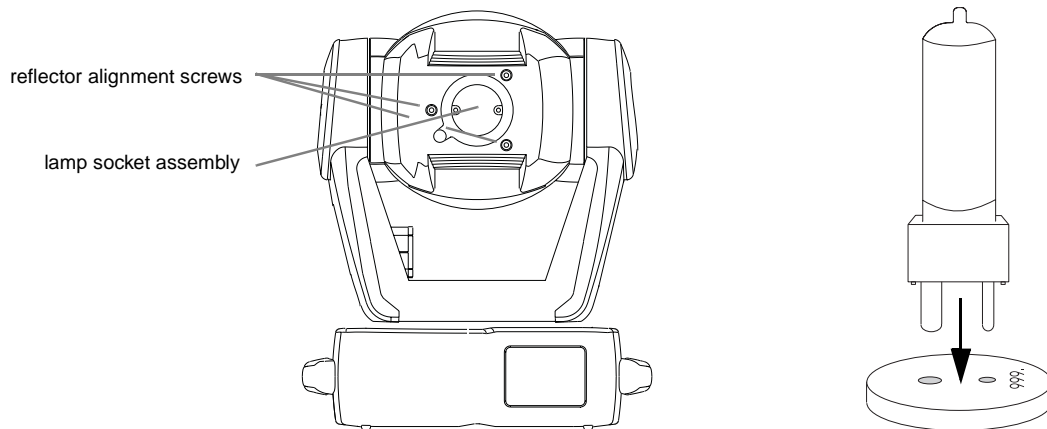

Figure 1: Lamp installation

To install a lamp

1. Remove the 2 Phillips screws from the lamp socket assembly. Pull the lamp and socket out of the head.
2. Remove the old lamp, if any, from the socket.
3. **Holding the new lamp by its ceramic base** (do not touch the glass), align the small pin with the small hole and insert the lamp squarely into the socket. Make sure that the 4 small projections on the base contact the face of the socket.
4. Clean the glass bulb with the cloth supplied with the lamp, particularly if your fingers touched the glass. A clean, lint-free cloth wetted with alcohol may also be used.
5. Gently insert the assembly, making sure the lamp fits through the opening in the reflector. Replace the 2 screws.
6. The reflector is pre-adjusted at the factory; however, precise alignment to compensate for variations between lamps may improve performance. See "Optimizing reflector alignment" on page 15.

Powering

WARNING!

For protection from dangerous electric shock, the fixture must be grounded (earthed). The AC mains supply shall be fitted with a fuse or circuit breaker and ground-fault protection.

1. Verify that the voltage and frequency settings match the local AC supply. The factory settings are printed on a label under the base. Check Table 7 on page 20 to verify that these settings are correct for your local AC voltage. Operating at the incorrect power setting can result in poor light output, greatly reduced lamp life, overheating and damage to the fixture. Refer to "Changing voltage and frequency settings" on page 20 if the settings need to be adjusted.
2. Install a grounding-type cord cap that fits your supply on the power cable. Following the manufacturer's instructions, connect the yellow/green wire to the ground (earth) pin, the blue wire to the neutral pin, and the brown wire to the live pin. The table shows some possible pin identification schemes; if the pins are not clearly identified, or if you have any doubts about proper installation, consult a qualified electrician.

Wire	Pin	Marking	Screw (US)
brown	live	"L"	yellow or brass
blue	neutral	"N"	silver
yellow/green	ground		green

Table 1: Cord cap wiring

3. Verify that the supply cable is undamaged and rated for the current requirements of all connected devices.
4. Plug the prepared power cable into the 3-prong IEC inlet and a grounded AC power supply. Do not connect the fixture to a dimmer system.

Rigging

The *MAC 250* and *MAC 250⁺* include a clamp mounting bracket to which 1 or 2 rigging clamps (not included) can be bolted. The clamp mounting bracket fastens to the base as shown with 1/4-turn fasteners.

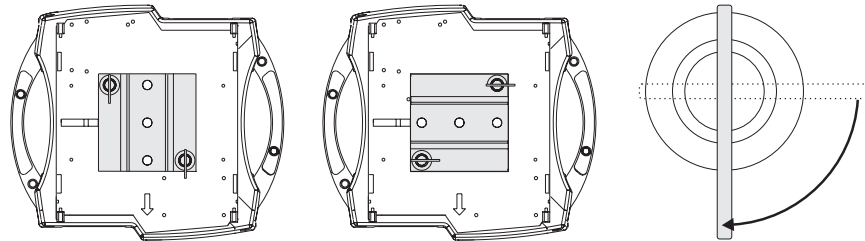

Figure 2: Clamp mounting bracket

WARNING!

Always use an approved safety cable.
The 1/4-turn fasteners are locked only when turned fully clockwise.

1. Verify that the clamps are in good condition and can bear at least 10 times the weight of the fixture. Bolt clamps to the bracket with a grade 8.8 (minimum) M12 bolt and lock nut, or as recommended by the clamp manufacturer, through the 13 mm holes in the clamp mounting bracket.
2. Align the clamp mounting bracket with any 2 key slots on the base. Insert both locking pins into the slots and turn both levers a full 1/4 turn clockwise to lock.
3. Verify that the structure can bear at least 10 times the weight of all installed fixtures, clamps, cables, auxiliary equipment, etc.
4. Working from a stable platform, clamp the fixture to the structure.
5. Install a safety cable that can bear at least 10 times the weight of the fixture securely to the structure and anchor the cable to the dedicated attachment point on the base. The attachment point is designed to fit a carabiner clamp.

Connecting the serial data link

The *MAC 250* and *MAC 250⁺* have locking 3-pin data input and output sockets that are wired for use with DMX devices, that is, pin 1 to shield, pin 2 to cold (-) and pin 3 to hot (+). As some devices have 5-pin connectors, or 3-pin connectors with reversed polarity on pins 2 and 3, the following adaptor cables may be required.

5-pin to 3-pin Adaptor		3-pin to 5-pin Adaptor		3-pin to 3-pin Phase-Reversing Adaptor	
Male	Female	Male	Female	Male	Female
1	1	1	1	1	1
2	2	2	2	2	3
3	3	3	3	3	2
4			4		
5			5		
P/N 11820005		P/N 11820004		P/N 11820006	

Figure 3: Cable adaptors

1. Connect the controller's output to the fixture's data input. For a **DMX controller with 5-pin output**, use a cable with a 5-pin male and a 3-pin female connector, such as P/N 11820005. For a **DMX controller with 3-pin output**, use a 3-pin cable such as the one included. For a Martin RS-485 protocol controller, use a phase reversing cable or reconfigure the pin-out as described on page 19.
2. Connect the output of the fixture closest to the controller to the input of the next fixture. When connecting a fixture with pin 3 hot to a fixture with pin 3 cold, use a phase-reversing adaptor.
3. To terminate the link, insert a male 120 Ω XLR termination plug in the output of the last fixture.

Tips for building a serial link

- Use shielded twisted-pair cable designed for RS-485 devices: standard microphone cable cannot transmit DMX data reliably over long runs. For links up to 300 meters (1000 ft.) long, you can use 24 AWG, low capacitance, 85-150 ohm characteristic impedance, shielded cable with 1 or more twisted pairs. For runs up to 500 meters (1640 ft.) use 22 AWG cable. Use an amplifier if the serial link exceeds 500 meters.
- Never use a “Y” connector to split the link. To split the serial link into branches use a splitter such as the Martin 4-Channel Opto-Isolated RS-485 Splitter/Amplifier.
- Do not overload the link. Up to 32 devices may be connected on a serial link.
- Terminate the link by installing a termination plug in the output socket of the last fixture on the link. The termination plug, which is simply a male XLR connector with a 120 ohm, 0.25 watt resistor soldered between pins 2 and 3, “soaks up” the control signal so it does not reflect back down the link and cause interference. If a splitter is used, terminate each branch of the link.

section 3 CONTROL PANEL

You set the fixture address, mode, and personalities; read lamp hours, DMX values, and other information; calibrate effects, control the fixture manually, and run test and demo programs from the LED control panel. Functions that do not require feedback can also be performed remotely via the serial link using a Martin uploader.

The display can be flipped for easy reading by pressing the [↑] and [↓] keys simultaneously. The intensity can be adjusted and the display can be set to black out 2 minutes after the last key-press.

Menu navigation

The DMX or Martin address, depending on the mode, and any error messages are displayed after the fixture resets. To enter the menu, press [MENU]. Use the [↑] and [↓] keys to move within the menu. To select a function or submenu, press [ENTER]. To escape a function or menu, press [MENU].

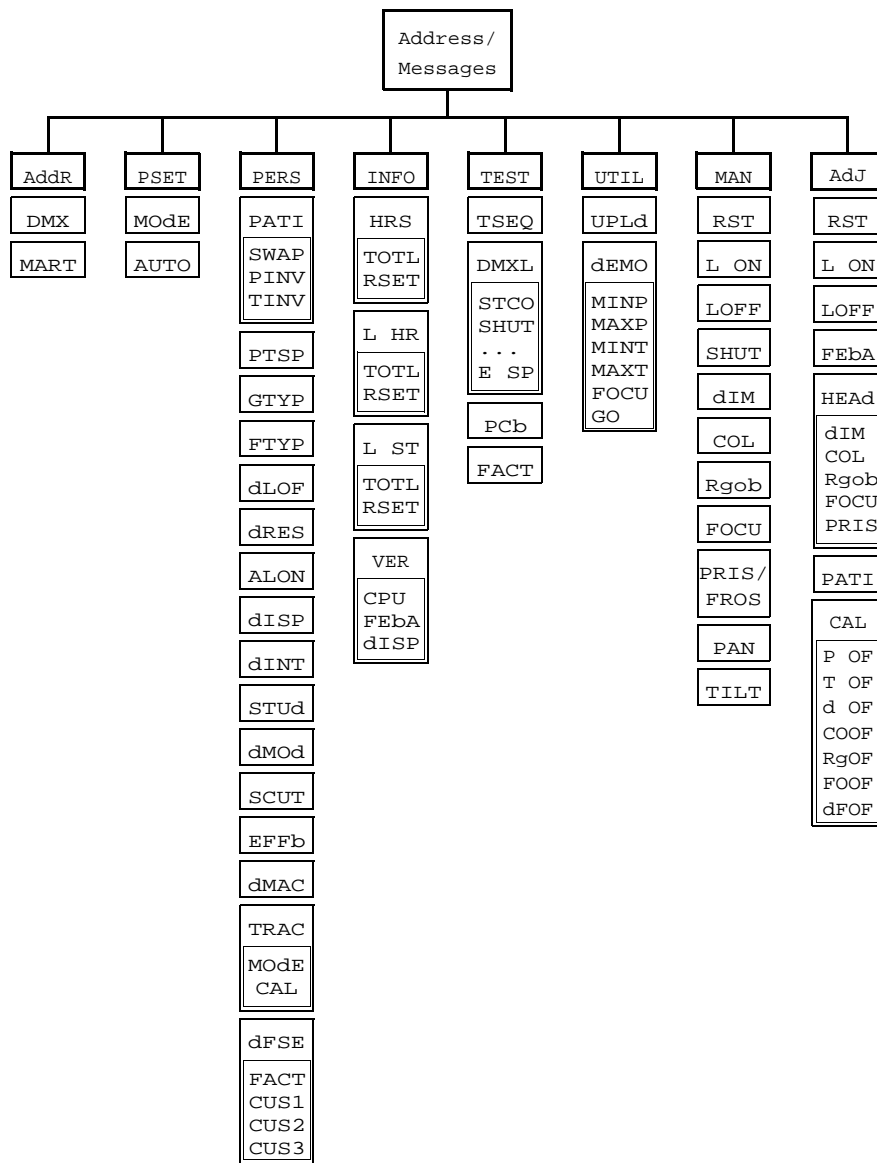

Figure 4: MAC 250 and MAC 250⁺ menu

Personality settings (PERS)

Personality	Path	Options	Effect (Default setting shaded, * indicates DMX override)
Pan/tilt swap	PATI / SWAP	ON	Map DMX pan control to tilt channel and vice versa.
		OFF	Normal pan and tilt control.
Pan inverse	PATI / PINV	ON	Reverse DMX pan control (right → left).
		OFF	Normal pan control (left → right).
Tilt inverse	PATI / TINV	ON	Reverse DMX tilt control (down → up).
		OFF	Normal tilt control (up → down).
Pan/tilt speed	PTSP	FAST	Optimize movement for speed.*
		SLOW	Optimize movement for smoothness.*
Gobo type	GTYP	STd	Select non-indexible gobos (MAC 250).
		INDX	Select indexible gobos (MAC 250+).
Fixture type	FTYP	PRIS	Operate with rotating prism.
		FROS	Operate with optional frost (available soon).
DMX lamp off	dLOF	ON	Enable DMX lamp off command.
		OFF	Disable DMX lamp off command.*
DMX reset	dRES	ON	Enable DMX reset command.
		OFF	Disable DMX reset command.*
Automatic lamp on	ALON	ON	Lamp strikes automatically within 90 seconds of power on.
		OFF	Lamp remains off until “lamp on” command is sent.
Display on/off	dISP	ON	Display stays on.
		OFF	Display goes out 2 minutes after last key press.
Display intensity	dINT	10 - 100	Adjust display intensity.
Studio mode	STUD	ON	Optimize effects for silence.
		OFF	Optimize effects for speed.
Dimmer mode	dMOD	NORM	Normal dimming curve.
		TUNG	Simulated tungsten dimming curve.
Shortcuts	SCUT	ON	Color and gobo wheels turn the shortest direction.*
		OFF	Wheels turn same direction.*
Effects feedback	EFFb	ON	Enable feedback on color and gobo wheels.
		OFF	Disable feedback on color and gobo wheels.
DMX macros	dMAC	ON	Enable DMX-selectable macros and pulsating effects.
		OFF	Disable DMX-selectable macros and pulsating effects.
Tracking algorithm	TRAC / MOdE	MOd1	Absolute delta value algorithm (for most controllers)
		MOd2	Real delta value algorithm
Tracking samples	TRAC / CAL	1 - 10	Tracking samples. Increase if pan/tilt is not smooth.
Default settings	dFSE	FACT	Select factory default personality settings.
		CUS1	Save / load custom personality settings. To create a custom configuration, select SAVE after setting the personalities as desired. Select LOAD to recall the settings.
		CUS2	
		CUS3	

Table 2: Personality settings

Address and protocol selection

Mode	DMX 1	DMX 2	DMX 3	DMX 4	Martin
Movement speed	Tracking		Tracking and/or Vector		Vector
Pan/tilt resolution	8 bit	16 bit	8 bit	16 bit	16 bit
Channels required	9	11	11	13	2

Table 3: Control modes

The fixture address and operating mode must be selected before the *MAC 250* or *MAC 250⁺* will respond to the controller. DMX mode 4 provides full control and is recommended unless channels are limited. See “DMX-512 control” on page 12 for factors to consider when selecting other DMX modes.

The address, also known as the start channel, is the first channel used to receive instructions from the controller. For independent control, each fixture must be assigned its own address and non-overlapping control channels. Two fixtures may share the same address only if they are to respond identically: they will receive the same instructions and individual control will not be possible.

If automatic protocol detection (AUTO) is ON, the fixture automatically switches to DMX or Martin mode after interpreting the control signal. This allows you to set the fixture up for both DMX and Martin controllers. If it is OFF, the default, the operating mode must match the controller. *Note: automatic protocol detection does not detect the DMX mode (1, 2, 3, or 4) setup on the controller.*

1. Apply power to the *MAC 250* or *MAC 250⁺*. Press [MENU] on the control panel to enter the main menu.
2. Select ADDR using the arrow keys. Press [ENTER].
3. Select DMX (to set a DMX address) or MART (to set a Martin address) using the arrow keys. Press [ENTER].
4. Select the address using the arrow keys. Press [ENTER]. Press [MENU] to return to the main menu.
5. Select PSET using the arrow keys. Press [ENTER].
6. Select MODE using the arrow keys. Press [ENTER].
7. Select DMX1, DMX2, DMX3, or DMX4 if using a DMX controller, or MART if using a Martin 3032 controller. Press [ENTER].
8. Press [MENU] to return to the main menu. Press [MENU] again to display the address.

Readouts (INFO)

Use the counters to track usage, maintenance intervals, lamp life, etc. To reset a counter, display the readout and press [↑] for 5 seconds. Counters showing totals are not resettable.

Hours used (HRS)

Read the total number of hours the fixture has been on (TOTL), and the number of hours on since the counter was last reset (RSET).

Lamp hours (L HR)

Read the total number of hours used with the lamp on (TOTL), and the number of lamp hours since the counter was last reset (RSET). Reset this counter when installing a new lamp.

Lamp strikes (L ST)

Read the total number of lamp strikes (TOTL), and the number of lamps strikes since the counter was last reset (RSET). Reset this counter when installing a new lamp.

Software version (VER)

Read the version number of the CPU software (CPU), feedback circuit software (FEBA), and display module software (DISP).

Utilities (UTIL)

Upload mode (UPLd)

Upload mode is normally engaged automatically by the uploader. In certain circumstances, however, you may have to set upload mode manually. See “Updating software” on page 19.

Demonstration program (dEMO)

This menu offers a preprogrammed stand-alone demonstration. Before running the demo, set the minimum and maximum pan and tilt positions (MINP, MAXP, MINT, MAXT) to a good location for viewing the effects. Select FOCU to focus the beam. Select GO to run the demo.

Test programs (TEST)

Effects test sequence (TSEQ)

Run a general test of all effects.

DMX log (DMXL)

Read the DMX start code (STCO) and DMX values received for each effect. This is an easy way to check that the DMX start code is 0 and that the expected DMX values are received.

Quality control and service tests (PCb, FACT)

These menus contain tests for factory and service use.

Manual control (MAN)

The manual control menu permits you to do the following from the control panel:

- reset the fixture (RST)
- turn the lamp on and off (L ON, LOFF)
- open, close, and strobe the shutter at 3 speeds (SHUT)
- control the dimmer (DIM)
- move the color wheel to each position and scroll it at 3 speeds (COL)
- move the gobo wheel to each position and rotate the gobos at 3 speeds (Rgob)
- control the focus (FOCU)
- insert and rotate the prism (PRIS) at 3 speeds, or, if a frost filter is installed, insert the frost (FROS)
- control pan and tilt (PAN, TILT)

Adjustment (AdJ)

The adjustment menu provides the following functions:

- Reset the fixture (RST)
- Turn on and off the lamp (L ON, LOFF)
- Disable pan/tilt feedback (FEbA)
- Control effects in the head (HEAd)
- Move the head to the home and extreme positions (PATI)
- Calibrate effects (CAL)

Head effects adjustment (HEAd)

The head submenu provides manual control when making mechanical adjustments, which should be performed by a qualified technician. It allows the technician to:

- Open, close, and strobe the dimmer/shutter (DIM)
- Move the color and gobo wheels through their positions (COL, Rgob)
- Move the focus lens to its extreme positions (FOCU)
- Insert and rotate the prism (PRIS)

Calibration (CAL)

The calibration submenu allows you to adjust the effects to achieve total uniformity between fixtures: it is not a substitute for mechanical adjustment. To reset all calibrations to their factory defaults, select dFOF and press [ENTER] when SURE is displayed, or press [MENU] to escape.

1. Select the effect to calibrate: pan (POF), tilt (TOF), dimmer/shutter (dOF), color wheel (COF), rotating-gobo wheel (RgOF), or focus (FOOF).
2. Adjust the effect using the arrow keys until it matches the other units when set at the same control value. Offsets are adjustable from 1 to 255. Press [ENTER] to save the calibration.

section 4 OPERATION

This section describes the effects and how personality settings affect their behavior. Selecting personalities from the control panel is described in the previous section.

DMX-512 control

The *MAC 250* and *MAC 250*⁺ can be operated with DMX-512 controllers in 4 modes that combine vector and/or tracking control with 8-bit or 16-bit pan/tilt resolution.

Tracking control

With tracking control, the speed at which effects move is set by programming a cross-fade *time* on the controller. The controller divides the move into steps and updates the fixture with small changes at the rate required to achieve the fade. The fixture tracks the changes and averages them with a digital filter algorithm to provide smooth movement at all speeds.

This algorithm is adjustable to compensate for controllers that calculate position changes unevenly. In most cases the default settings work well. If movement is not satisfactory there are 2 parameters that can be adjusted. The first is the calculation method used and is selected under `PERS / TRAC / MODE`. `MOD 1`, the default, calculates speed based on the absolute value of the change in DMX; it is the best choice with controllers that calculate intermediate positions that are close to the line of travel. `MOD 2` uses the real value of the DMX delta to calculate speed and is better if the intermediate positions stray significantly from the line of travel.

The second parameter is the number of position updates used to calculate speed. The level is adjustable between 1 and 10 under `PERS / TRAC / CAL`. Increasing the number of samples increases the distance over which speed is calculated, making movement smoother but less responsive to sudden changes.

The ideal settings for both parameters will vary from controller to controller: experiment for best results.

Vector control

With vector control, you set the *speed* on a speed channel. This provides a way to control speed on controllers without cross-faders. Vector control also provides smoother movement, particularly at slow speeds, with controllers that send slow or irregular tracking updates, plus a “blackout speed” and overrides of the shortcut and pan/tilt speed personality settings. *When using vector speed, the cross-fade time must be 0.*

Tracking control can be enabled in vector mode by setting one or both of the speed channels to “tracking speed.”

8-bit versus 16-bit pan/tilt resolution

With 8-bit pan/tilt resolution, pan and tilt are divided into 256 equal increments. Finer position control and smoother movement are provided in 16-bit mode, which divides pan into 40,192 positions and tilt into 43,008 positions.

Martin RS-485 control

The *MAC 250* is fully supported by the Martin 3032 controller with version 2.05 or higher software. The *MAC 250*⁺ may be set up on the 3032 as a *MAC 250*: gobo indexing, however, is not supported. To respond to the 3032, Martin mode must be selected or automatic protocol detection must be enabled as described on page 10.

Controllable effects

All mechanical effects are reset to a home position when the fixture is powered up. They can also be reset via DMX. Accidental resets can be prevented by turning DMX Reset (`PERS / dRES`) off.

An on-the-fly position correction system automatically corrects the position of the color and gobo wheels; this feature can be disabled by turning Effects Feedback (`PERS / EFFb`) off.

General operation may be optimized for speed or quietness with the Studio Mode setting (`PERS / STUd`).

Lamp

With the default setting, the lamp remains off until a “lamp on” command is sent from the controller. Note: A peak of electric current that can be many times the operating current is drawn for an instant when striking a discharge lamp. Striking many lamps at once may cause a voltage drop large enough to prevent lamps from striking or draw enough

current to trip circuit breakers. If sending “lamp on” commands to multiple fixtures, program a sequence that strikes lamps one at a time at 5 second intervals.

The fixture automatically strikes the lamp within 90 seconds of being powered on if the Automatic Lamp On setting (PERS / ALON) is turned on. A delay determined by the fixture address staggers lamp strikes to prevent excessive voltage drop and current draw.

The lamp can be turned off from the controller. Note: the lamp cannot be restruck for 8 minutes after being turned off. Accidental “lamp off” commands can be prevented by turning the DMX Lamp Off setting (PERS / dLOF) off.

Color

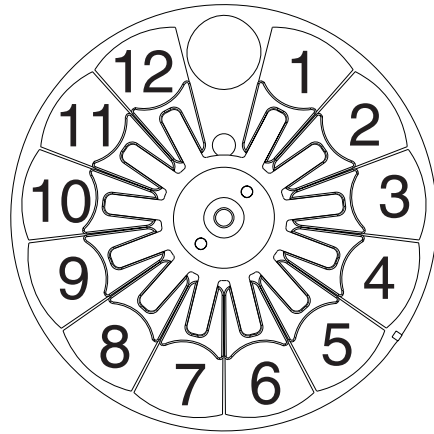

MAC 250+ color wheel shown

Position	Color
1	CTC
2	Yellow 603
3	Blue 104
4	Pink 312
5	Green 206
6	Blue 108
7	Red 301
8	Magenta 507
9	Blue 101
10	Orange 306
11	Green 202
12	Purple 502

Table 4: Color positions

The MAC 250 and MAC 250+ color wheel provides a 5500 to 2900K color temperature correction (CTC) filter and 11 dichroic color filters. The wheel can be scrolled continuously - allowing for split color effects - or in steps, and rotated randomly or continuously in both directions at different speeds.

The Shortcuts setting (PERS / SCUT) determines whether or not the wheel takes the shortest path to the next position; this setting may be overridden on the speed channel in vector mode. Setting the effects speed to “blackout” causes the shutter to black out the light while the wheel is moving.

The color filters on the MAC 250+ are interchangeable. See page 16.

Rotating gobos

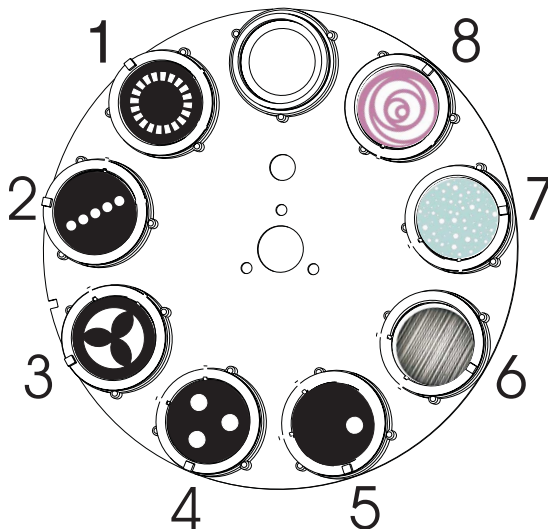

Position	Gobo
1	Radial Dashes
2	Line of Beams
3	Fan Hat
4	Triple Beam
5	Decentered Beam
6	Fibroid
7	Random Holes, Blue
8	Psycho Circles, Magenta

Table 5: Gobo positions

The MAC 250 and MAC 250+ has 8 rotating gobo positions plus an open position. Each gobo rotates and/or “shakes” at varying speeds. Gobos and shake are selected on channel 4; rotation is set on channel 5. The gobo wheel also rotates continuously in both directions at variable speed.

The *MAC 250*⁺ provides gobo indexing as well. Select the gobo on channel 4, between the DMX values of 5 and 44, and set the position on channel 5. The gobo type setting (*PERS / GTYPE*) automatically defaults to *INDX* in the *MAC 250*⁺ to enable this feature. It defaults to *STD* in the *MAC 250*.

The Shortcuts setting (*PERS / SCUT*) determines whether or not the wheel takes the shortest path to the next position; this setting may be overridden on the effects speed channel. Setting the speed to “blackout” causes the shutter to black out the light while the wheel turns.

To change the gobos, see “Rotating gobos” on page 15.

Dimmer / shutter

The mechanical dimmer/shutter system provides full, high-resolution dimming, “instant” open and blackout, random and variable strobe effects, and random and variable pulses in which the dimmer snaps open and slowly dims or snaps closed and slowly opens. Pulse and random strobe effects can be disabled by switching DMX Macros (*PERS / dMAC*) off.

The Dimmer Mode (*PERS / dMOD*) setting allows you to select between linear or simulated tungsten fade curves. The fade time must be 0 to simulate tungsten dimming.

Focus

The beam may be focused from approximately 2 meters (6.5 feet) to infinity. The *MAC 250*'s default beam angle is 17.5°; see page 17 for additional options. The *MAC 250*⁺ has a different optical system that uses achromatic lenses. It provides a beam angle of 18.3°.

Rotating prism

The 3-facet prism rotates in both directions at varying speeds. There are 8 preprogrammed macros that combine prism and gobos. These can be disabled by switching DMX Macros (*PERS / dMAC*) off. Setting the speed to “blackout” causes the shutter to black out the light while the prism moves in and out.

Pan and tilt

The yoke pans 540° and the head tilts 289°. Movement may be optimized for speed by setting the pan/tilt speed setting (*PERS / PTSP*) to *FAST*, or for smoothness by setting it to *SLOW*. This setting may be overridden on the speed channel in vector mode. Setting the speed to “blackout” causes the shutter to black out the light while the head is moving. The pan and tilt channels can be inverted and/or swapped using the pan/tilt menu (*PERS / PATI*).

section 5 BASIC SERVICE

The *MAC 250* and *MAC 250⁺* operate under challenging conditions presented by heat, humidity, dust, and touring. Excessive dust, grease, and smoke fluid buildup degrades performance and causes overheating and damage that is not covered by the warranty. The *MAC 250* and *MAC 250⁺* require regular maintenance to keep performing at their peak. The schedule will depend on the application and should be discussed with your Martin distributor. Refer any service that you are not qualified to perform to a professional technician.

WARNING!

Removing covers exposes dangerous live electrical circuits, hot surfaces, and a lamp under high pressure. Procedures requiring the removal of any cover shall be performed by professional users or technicians only. Disconnect the fixture from AC power and allow it to cool before removing any cover.

Replacing the lamp

If the lamp becomes difficult to strike, it probably needs to be replaced. To reduce the risk of lamp explosion, which may damage the fixture, do not exceed the lamp's rated life (2000 hours) by more than 25 percent.

Refer to page 5 for the lamp replacement procedure. After installing the lamp, reset the lamp usage counters as described on page 10.

Optimizing reflector alignment

The reflector is aligned at the factory. Due to differences between lamps, however, fine adjustment may improve performance.

1. Strike the lamp and focus the light on a flat surface.
2. See Figure 1 on page 4. Center the hot-spot (the brightest part of the beam) by turning the 3 adjustment screws one at a time with a 3 mm Allen wrench. If there is no hot-spot, adjust the reflector until the light is even.
3. To reduce a hot-spot, "push" the reflector out by turning all 3 screws counterclockwise 1/4-turn at a time until the light is evenly distributed.
4. If the light is brighter around the edge than it is in the center, or if light output is low, the lamp is too far back in the reflector. "Pull" the reflector in by turning the screws clockwise 1/4-turn at a time until the light is bright and evenly distributed.

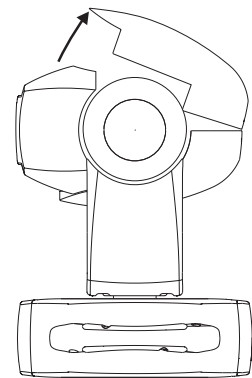
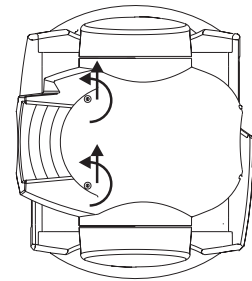

Figure 5

Rotating gobos

Custom glass gobos for the *MAC 250* and *MAC 250⁺* should be made with any non-reversible graphics true on the coated side. Complete gobo specifications are listed on page 27. Do not use chrome-coated glass gobos: they absorb more heat than enhanced aluminum gobos and are likely to break or oxidize.

Changing gobos

1. Disconnect the fixture from AC power and allow it to cool. Remove the top head shell as shown in Figure 5.
2. Turn the gobo wheel until the gobo lines up with the access hole. Squeeze the ends of the retention spring together and remove. Push the gobo out from the back.
3. Insert the new gobo. See Figure 7 for proper orientation.
4. Replace the gobo retention spring.

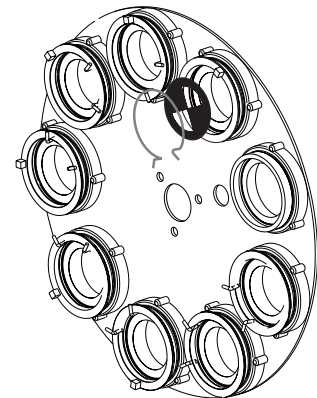

Figure 6

Gobo orientation

Figure 7 shows the correct orientation for different gobo types. When in doubt, install gobos with the more reflective side towards the lamp.

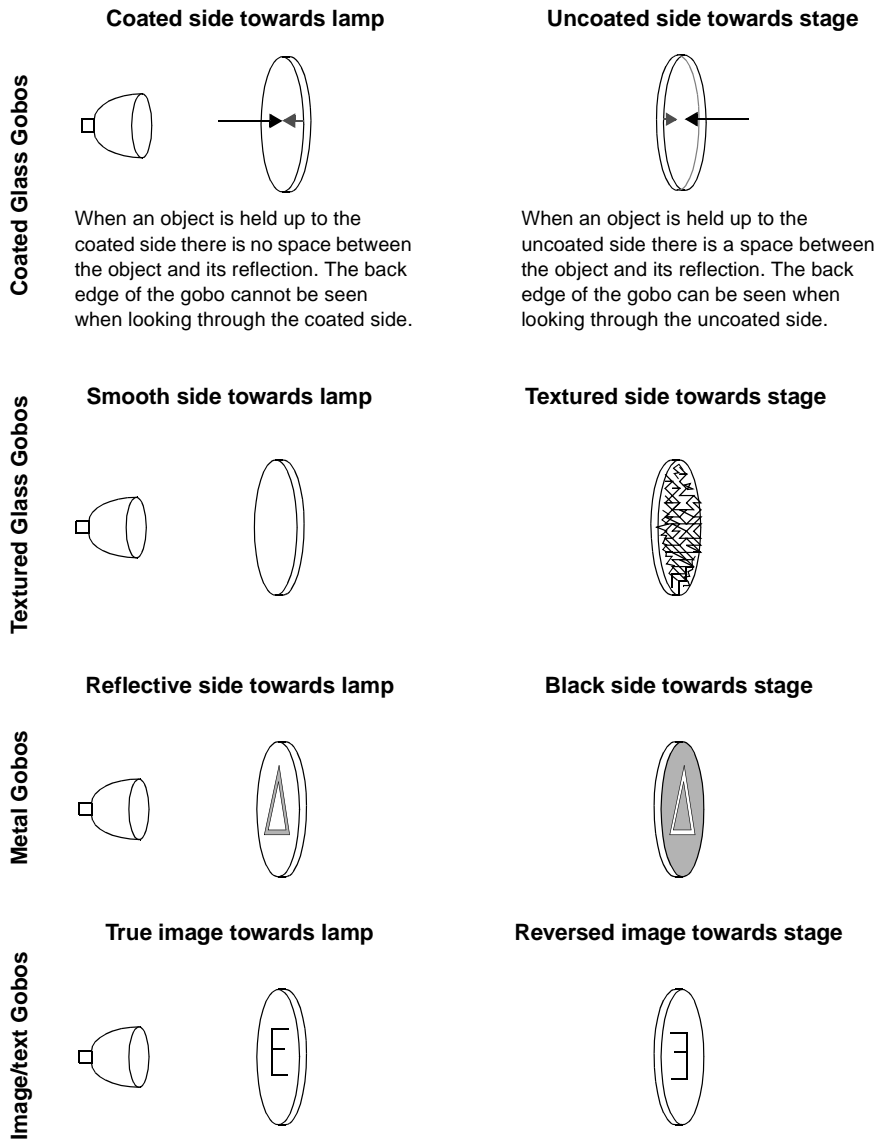

Figure 7: Gobo orientation

Changing color filters (MAC 250+ only)

1. Disconnect the fixture from AC power and allow it to cool.
2. Remove the top head shell as shown in Figure 5.
3. Turn the color wheel so the desired color filter is in front of the access hole. Press the filter forwards slightly to release it and then grasp it by the edges and remove.
4. To insert a filter, slide it under the retention spring until it snaps into place.
5. Replace the top head shell.

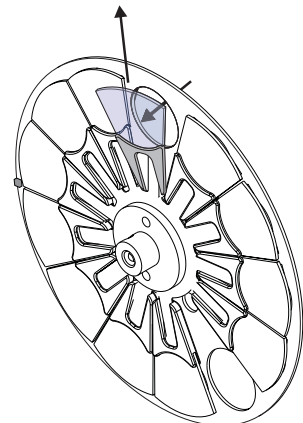

Figure 8

Configuring the optical system (MAC 250 only)

Beam angle options

The standard MAC 250 lens system can be configured for 4 beam angles ranging from 12.1° to 23.3°. The beam angle in the default 4-lens configuration is 17.5°. Other beam angles are achieved by removing lenses and positioning the dimmer module as shown below. Note: dimming will be somewhat less even in the 12.1° configuration.

To calculate the projected size of an image, divide the gobo's image diameter by the focal length and then multiply by the distance in meters.

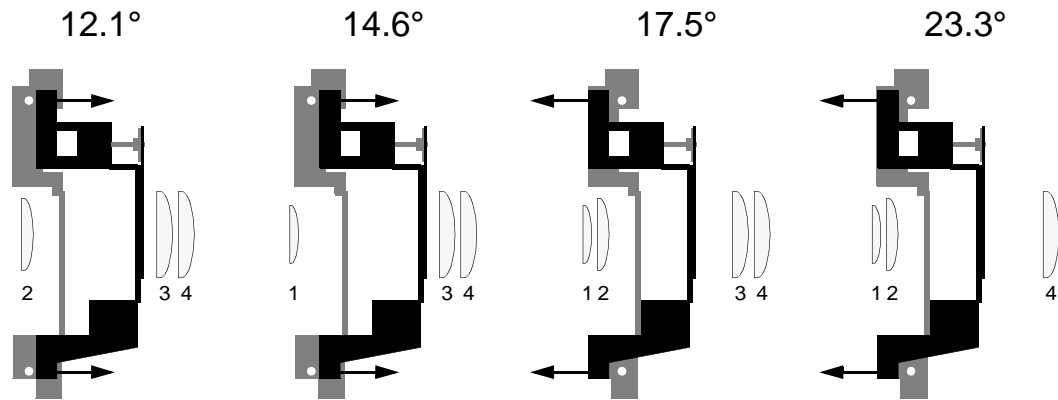

Figure 9: MAC 250 optical configurations

Beam Angle	Focal Length	Remove Lens	Dimmer Position
12.1°	80.2 mm	1 (40 mm)	forward
14.6°	66.3 mm	2 (50 mm)	forward
17.5°	55.2 mm	-	rear
23.3°	41.2 mm	3 (60 mm)	rear

Table 6: MAC 250 optical configurations

Changing beam angle

Verify that lenses and retention springs are fully seated.

1. Disconnect the fixture from AC power and allow it to cool.
2. Remove the top head shell as shown in Figure 5.
3. Remove and/or replace lenses as required.

To remove lens 1, first remove lens 2 as described next. Then pull out the retention spring for lens 1 and tilt the module or head until the lens drops out. Catch it in a soft cloth. Store the lens together with the spring in a safe place. Replace lens 2 and the module(s).

To remove lens 2, remove either the color/gobo/focus module or the dimmer and prism modules as described below. Pull out the retention spring for lens 2 and tilt the module or head until the lens drops out. Catch it in a soft cloth. Store the lens together with the spring in a safe place. Replace the module(s).

To remove lens 3, pull the lens clip back. Tilt the head until the lens drops out and catch it with a soft cloth. Store the lens together with the spring in a safe place.

4. Move the dimmer module to the forward or rear position as indicated in Figure 9. Make sure as you position the module that the bottom sits between the guide pins in the bottom shell. Pull the locking pins up and then snap them down to lock.
5. Replace the head cover. Position the holes by the lens opening over the nipples and check that all wires are inside the head as you lower the cover into place. Push the locking pins in with a flat-tip screwdriver and turn them clockwise until they lock (1/2 turn).

Removing modules

Color/gobo/focus module

1. Disconnect the fixture from AC power and allow it to cool.
2. Remove the top head shell as shown in Figure 5.
3. *MAC 250*: Unplug the wires from the color and gobo wheel sensors and the 3 top motors.
MAC 250+: Unplug the wires from the color wheel sensor and the 3 top motors. Unplug the outside connector from the junction print behind the gobo wheel.
4. Pull up the 2 plastic locking pins to release the module. Move the starter wires aside and lift the module partially out. Unplug the wires from the bottom motor.

Dimmer module

1. Disconnect the fixture from AC power and allow it to cool.
2. Remove the top head shell as shown in Figure 5.
3. Note whether the module is in the forward or rear position. (The *MAC 250+* gives best results with the dimmer in the forward position.)
4. Unplug the wires from the top dimmer motor. Pull up the 2 plastic locking pins to release the module. Unplug the wires from the bottom motor.

Prism module

1. Disconnect the fixture from AC power and allow it to cool.
2. Remove the top head shell as shown in Figure 5.
3. Remove the dimmer module.
4. Pull the 2 plastic locking pins to release the prism module. Lift the module partially out and unplug the wires from motors.

Cleaning

Optical components

Use care when cleaning optical components. The surface on dichroic filters is achieved by means of special multi-layer coatings and even small scratches may be visible. Residues from cleaning fluids can bake onto components and ruin them.

1. Allow the components to cool completely.
2. Wash dirty lenses and filters with isopropyl alcohol. A generous amount of regular glass cleaner may also be used, but no residues may remain.
3. Rinse with distilled water. Mixing the water with a small amount of wetting agent such as Kodak Photoflo will help prevent streaking and spotting.
4. Dry with a clean, soft and lint-free cloth or blow dry with compressed air.

Fans

To maintain adequate cooling it is important that the fans be cleaned of dust and dirt periodically. Use a soft brush, vacuum, or compressed air.

Lubrication

Use silicone lubricant, Martin P/N 37302003 (500 ml) or P/N 37302004 (200 ml, in applicator bottle). No other lubricant is approved for use. When applying lubricant, always remove excess and do not get oil on other parts.

Check the focus mechanism when the head is open and apply a drop of lubricant to the 3 metal slides if movement is rough.

Lubricate the rotating-gobo bearings if movement is rough on slow rotation or if they become noisy. Apply a few drops of oil to each bearing from the lamp side of the wheel.

Replacing fuses

Power supply fuses

The fuses for each of the 3 low-voltage power supplies are located on the printed circuit board. If one of the circuit board LEDs does not light, one of these fuses may be blown.

1. Disconnect the fixture from AC power. Remove the 2 Philips screws from the plastic cover on the arm opposite the side with the visible motor and pull off the cover.
2. Locate and replace the defective fuse with one of the same rating. The fuses are shown on the PCB layout diagram; their values are listed on page 27.
3. Replace the cover before applying power.

Main fuse

The main fuse holder is built in to the mains input socket. *Never replace the fuse with one of a different rating!*

1. Unplug the mains cable from the input socket.
2. Pry open the fuse holder and remove the fuse.
3. Replace the fuse with one of the same type and rating. The fuse rating is listed on serial number label.
4. Close the fuse holder and replace the mains cable.

Changing the XLR pin-out

The signal polarity of pins 2 and 3 on the XLR connectors can be reversed, allowing the fixture to be connected directly to Martin devices wired with pin 3 cold (-). Optionally, a phase-reversing cable may be used.



1. Disconnect the fixture from AC power. Remove the 2 Philips screws from the plastic cover on the arm opposite the side with the visible motor and pull off the cover.
2. Position the jumpers on PL 233 and PL 234 for the desired XLR pin-out as shown.
3. Replace the cover before applying power.

Figure 10: XLR jumpers

Updating software

The MAC 250 and MAC 250⁺ operate with the same software. Updates are available from your Martin dealer and the Martin Professional web site. Please read the update notes included with the software. Note: the software automatically defaults to the correct gobo type setting (P E R S / G T Y P) in unmodified fixtures.

Normal upload

Update software is uploaded to the MAC 250 and MAC 250⁺ using a Martin uploader such as the MPBB1. The uploader is connected to the fixture just like a controller. Under normal conditions, software can be installed from a remote location - there is no need to set the MAC 250 and MAC 250⁺ to boot mode. Please refer to the uploader manual for further instructions.

Boot mode upload

If the data is corrupted during transmission, a check-sum error (C S E R) occurs and after 15 seconds the fixture switches to boot mode (U P L d) and is ready for a boot mode upload as described in the uploader manual.

If a software upload is interrupted, the fixture must be turned off for at least 10 seconds before a new upload can be attempted. When powered on, a check-sum error occurs and the fixture goes into boot mode, ready for a second upload attempt. Select boot mode upload on the uploader.

If there is no functional software in memory, the fixture must be set to boot mode manually. If the control panel works, select U P L d from the U T I L menu and confirm when S U R E is displayed by pressing [ENTER].

If the control panel does not work, boot mode can be engaged by moving jumper PL121 on the main circuit board to pins 1 and 2 as follows.

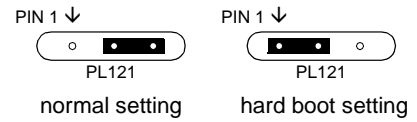

1. Disconnect the fixture from AC power. Remove the plastic cover from the arm opposite the side with the visible motor.
2. Move jumper PL121 to pins 1 and 2 (hard boot setting). See also the diagram on page 26.
3. Perform a boot-mode upload as described in the uploader manual.
4. Disconnect the fixture from AC power. Move the hard boot jumper back to the normal setting and replace the cover.

Figure 11: Hard boot jumper

Changing voltage and frequency settings

Local AC Voltage	50 Hz Setting	60 Hz Setting	Maximum power (watts)	Maximum current (amps)
95 - 110 V	100 V, 50 Hz	100 V, 60 Hz	350	4.1
110 - 130 V	120 V, 50 Hz	120 V, 60 Hz	350	3.2
200 - 220 V	210 V, 50 Hz	210 V, 60 Hz	370	2.2
220 - 240 V	230 V, 50 Hz	230 V, 60 Hz	360	1.8
240 - 260 V	250 V, 50 Hz	250 V, 60 Hz	370	1.7

Table 7: Power supply settings and consumption

If the factory voltage and frequency setting, shown on the serial number label, does not match local conditions, rewire the fixture as follows.

1. Disconnect the fixture from AC power. Remove the top base cover closest to the power inlet.
2. Find the correct setting for your AC voltage and frequency in Table 7.
3. Locate the 7-terminal connection block inside the base. Move the blue wire to the 0 or 20 V terminal, the brown wire to the 120, 230, or 250 V terminal; and the black wire to the 50 or 60 Hz terminal as shown for each setting in Figure 12.

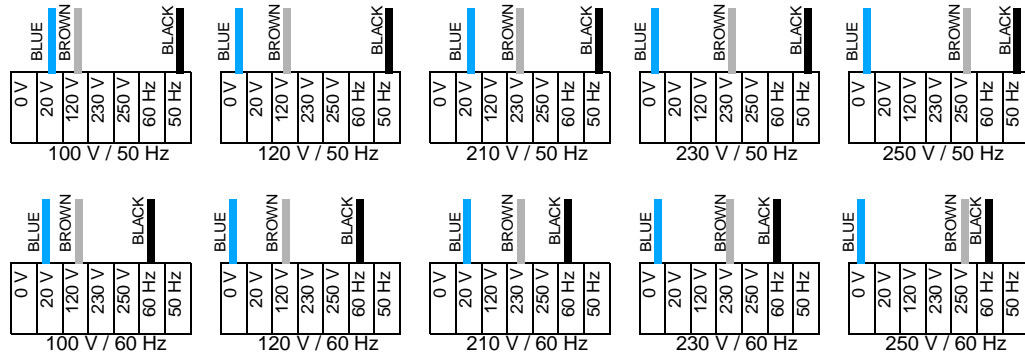

Figure 12: Voltage and frequency settings

section 6
APPENDIXES

DMX protocol

DMX1	DMX2	DMX3	DMX4	Value	Percent	Function
						Shutter, Strobe, Reset, Lamp On/Off
				0 - 19	0 - 7	Shutter closed
				20 - 49	8 - 19	Shutter open
				50 - 72	20 - 28	Strobe, fast→slow
				73 - 79	29 - 31	Shutter open
				80 - 99	31 - 39	Opening pulse, fast →slow
				100 - 119	39 - 47	Closing pulse, fast →slow
		1		120 - 127	47 - 50	Shutter open
				128 - 147	50 - 58	Random strobe, fast
				148 - 167	58 - 65	Random strobe, medium
				168 - 187	66 - 73	Random strobe, slow
				188 - 190	74 - 75	Shutter open
				191 - 193	75 - 76	Random opening pulse, fast
				194 - 196	76 - 77	Random opening pulse, slow
				197 - 199	77 - 78	Random closing pulse, fast
				200 - 202	78 - 79	Random closing pulse, slow
				203 - 207	80 - 81	Shutter open
				208 - 217	82 - 85	Reset fixture, see note 1
				218 - 227	85 - 89	Shutter open
				228 - 237	89 - 93	Lamp on
				238 - 247	93 - 97	Shutter open
				248 - 255	97 - 100	Lamp off: time > 5 seconds, see note 2
		2		0 - 255	0 - 100	Dimmer Closed → open
						Color
						Continuous Scroll: full color positions:
				0	0	White
				12	5	CTC
				24	9	Yellow 603
				36	14	Blue 104
				48	19	Pink 312
				60	23	Green 206
				72	28	Blue 108
				84	33	Red 301
				96	37	Magenta 507
				108	42	Blue 101
				120	47	Orange 306
				132	42	Green 202
				144	56	Purple 502
						Stepped Scroll
				156 - 159	61 - 63	Purple 502
				160 - 163	63 - 64	Green 202
		3		164 - 167	64 - 65	Orange 306
				168 - 171	66 - 67	Blue 101
				172 - 175	67 - 68	Magenta 507
				176 - 179	69 - 70	Red 301
				180 - 183	70 - 72	Blue 108
				184 - 187	72 - 73	Green 206
				188 - 191	74 - 75	Pink 312
				192 - 195	75 - 76	Blue 104
				196 - 199	77 - 78	Yellow 603
				200 - 203	78 - 79	CTC
				204 - 207	80 - 81	White
						Continuous Rotation
				208 - 226	82 - 88	CW, fast → slow
				227 - 245	89 - 96	CCW, slow → fast
						Random color
				246 - 248	96 - 97	Fast
				249 - 251	98 - 98	Medium
				252 - 255	99 - 100	Slow

DMX1	DMX2	DMX3	DMX4	Value	Percent	Function
						Gobo selection and shake
				0 - 9	0 - 3	Open gobo
				10 - 19	4 - 7	Gobo 1
				20 - 29	8 - 11	Gobo 2
				30 - 39	12 - 15	Gobo 3
				40 - 49	16 - 19	Gobo 4
				50 - 59	19 - 23	Gobo 5
				60 - 69	23 - 27	Gobo 6
				70 - 79	27 - 31	Gobo 7
				80 - 89	31 - 35	Gobo 8
	4					Shake
				90 - 104	35 - 41	Gobo 8 slow → fast
				105 - 119	41 - 47	Gobo 7 slow → fast
				120 - 134	47 - 52	Gobo 6 slow → fast
				135 - 149	53 - 59	Gobo 5 slow → fast
				150 - 164	59 - 64	Gobo 4 slow → fast
				165 - 179	65 - 70	Gobo 3 slow → fast
				180 - 194	70 - 76	Gobo 2 slow → fast
				195 - 209	76 - 82	Gobo 1 slow → fast
				210 - 232	82 - 91	Continuous rotation CW slow → fast
				233 - 255	91 - 100	CCW fast → slow
						Gobo selection and shake
						Indexing: set position on channel 5
				0 - 4	0 - 1	Open gobo
				5 - 9	1 - 3	Gobo 1
				10 - 14	3 - 5	Gobo 2
				15 - 19	6 - 7	Gobo 3
				20 - 24	7 - 9	Gobo 4
				25 - 29	9 - 11	Gobo 5
				30 - 34	11 - 13	Gobo 6
				35 - 39	13 - 15	Gobo 7
				40 - 44	15 - 17	Gobo 8
						Rotation: set velocity on channel 5
				45 - 49	17 - 19	Open gobo
				50 - 54	19 - 21	Gobo 1
				55 - 59	21 - 23	Gobo 2
				60 - 64	23 - 25	Gobo 3
				65 - 69	25 - 27	Gobo 4
				70 - 74	27 - 29	Gobo 5
				75 - 79	29 - 31	Gobo 6
				80 - 84	31 - 33	Gobo 7
				85 - 89	33 - 35	Gobo 8
						Rotation with shake, slow → fast: set velocity on ch. 5
				90 - 104	35 - 40	Gobo 8
				105 - 119	41 - 46	Gobo 7
				120 - 134	47 - 52	Gobo 6
				135 - 149	53 - 58	Gobo 5
				150 - 164	59 - 64	Gobo 4
				165 - 179	65 - 70	Gobo 3
				180 - 194	70 - 76	Gobo 2
				195 - 209	76 - 82	Gobo 1
				210 - 232	82 - 91	Continuous scroll: set velocity of gobo rotation on ch. 5 CW slow → fast
				233 - 255	91 - 100	CCW fast → slow
						Gobo rotation (select gobo on channel 4)
				0 - 255	0 - 100	Index position 0 - 395° (only if gobo type = indexed)
	5					Continuous rotation (direction and speed)
				0 - 2	0 - 1	No rotation
				3 - 127	1 - 50	CW, slow → fast
				128 - 252	50 - 98	CCW, fast → slow
				253 - 255	99 - 100	No rotation

DMX1	DMX2	DMX3	DMX4	Value	Percent	Function
6				0 - 255	0 - 100	Focus Infinity → 2 meters
7				0 - 19 20 - 79 80 - 89 90 - 149 150 - 215	0 - 7 8 - 31 31 - 35 35 - 58 59 - 84	Prism Prism off Rotating prism, CCW fast → slow No rotation Rotating prism, CW slow → fast Prism off
7				216 - 220 221 - 225 226 - 230 231 - 235 236 - 240 241 - 245 246 - 250 251 - 255	84 - 86 87 - 88 89 - 90 91 - 92 93 - 94 95 - 96 96 - 98 98 - 100	Prism/Gobo Macros Macro 1 Macro 2 Macro 3 Macro 4 Macro 5 Macro 6 Macro 7 Macro 8
8				0 - 255	0 - 100	Pan Left → right (128 = neutral)
-	9	-	9	0 - 255	0 - 100	Pan Fine (LSB) Left → right
9	10	9	10	0 - 255	0 - 100	Tilt Up → down (128 = neutral)
-	11	-	11	0 - 255	0 - 100	Tilt Fine (LSB) Up → down
-	-	10	12	0 - 2 3 - 245 246 - 248 249 - 251 252 - 255	0 - 1 1 - 96 96 - 97 98 - 98 99 - 100	Pan/Tilt Speed Tracking Fast → slow Tracking, PTSP NORM (menu override) Tracking, PTSP FAST (menu override) Blackout while moving
-	-	11	13	0 - 2 3 - 245 246 - 251 252 - 255	0 - 1 1 - 96 96 - 98 99 - 100	Effects Speed Dimmer, focus Tracking mode Fast → slow Tracking Maximum speed
-	-	11	13	0 - 2 3 - 245 246 - 248 249 - 251 252 - 255	0 - 1 1 - 96 96 - 97 98 - 98 99 - 100	Color Tracking mode Speed, fast → slow Tracking, SCUT OFF (menu override) Tracking, SCUT ON (menu override) Blackout while moving
-	-	11	13	0 - 245 246 - 248 249 - 251 252 - 255	0 - 96 96 - 97 98 - 98 99 - 100	Gobo selection Normal (no blackout) Normal, SCUT OFF (menu override) Normal, SCUT ON (menu override) Blackout while moving
-	-	11	13	0 - 2 3 - 245 246 - 251 252 - 255	0 - 1 1 - 96 96 - 98 99 - 100	Indexed gobo rotation (only if gobo type = indexed) Tracking mode Fast → slow Tracking Blackout while moving
-	-	11	13	0 - 251 252 - 255	0 - 98 99 - 100	Prism Normal (no blackout) Blackout while moving

Error messages

Display readout	Appears if...	What to do
AUTO (Automatic protocol detection error)	Automatic protocol detection is enabled and there is no control input.	<ul style="list-style-type: none"> • Verify that controller is connected properly and sending data.
LERR (Lamp error)	... the lamp doesn't ignite within 10 minutes of receiving the 'Lamp ON' command.	<ul style="list-style-type: none"> • Check the lamp • Check voltage and frequency settings
MERR (Memory error)	...the EEPROM memory cannot be read.	<ul style="list-style-type: none"> • Contact service technician.
CSER (Check-sum error)	...a software upload is unsuccessful.	<ul style="list-style-type: none"> • Reload software, see page 20.
****	... there is no communication between the control panel and motherboard. This appears briefly when switching on the fixture.	<ul style="list-style-type: none"> • Check fuses. • Check cable between control panel and motherboard. • Reinstall software. • Contact service technician.
ShER (Short error)	... the fixture detects the lamp is ON but no 'Lamp ON' command has been received. This can occur if the lamp relay is stuck.	<ul style="list-style-type: none"> • The fixture may be operated but remote lamp on/off may be effected. • Contact service technician.
Hot (Hot lamp)	... you attempt to strike the lamp within 8 minutes after having switched it off. The fixture will store the 'Lamp ON' instruction and strike the lamp once the 8 minutes period has elapsed.	<ul style="list-style-type: none"> • Wait until the lamp strikes.
FbEP (Feedback error pan) FbET (Feedback error tilt) FbER (Feedback error pan/tilt)	...pan (FbEp), tilt (FbET) or both (FbER) feedback circuits are malfunctioning.	<ul style="list-style-type: none"> • The fixture will still operate, though with reduced maximum speed to prevent the fixture from losing track of its position. • Contact service technician.
PAER (Pan time-out) TIER (Tilt time-out)	...the pan or tilt indexing circuit is malfunctioning.	<ul style="list-style-type: none"> • After the time-out the fixture will work normally. • Contact service technician.
COER (Color wheel time-out) RgER (Rot. gobo time-out)	...the magnetic-indexing circuit malfunctions (e.g. sensor defective or magnet missing).	<ul style="list-style-type: none"> • After the time-out, the effect in question stops in a random position. • Contact service technician.

Troubleshooting

Problem	Probable cause(s)	Remedy
One or more of the fixtures is completely dead.	No power to fixture.	Check that power is switched on and cables are plugged in.
	Primary fuse blown.	Replace fuse.
	Secondary fuse(s) blown (located on PCB inside base).	Check fuses on PCB and replace.
Fixtures reset correctly but all respond erratically or not at all to the controller.	The controller is not connected.	Connect controller.
	XLR pin-out of the controller does not match pin-out of the first fixture on the link (i.e. signal is reversed).	Install a phase-reversing cable between the controller and the first fixture on the link.
Fixtures reset correctly but some respond erratically or not at all to the controller.	Bad data link connection	Inspect connections and cables. Correct poor connections. Repair or replace damaged cables.
	Data link not terminated with 120Ω termination plug.	Insert termination plug in output jack of the last fixture on the link.
	Incorrect addressing of the fixtures.	Check address and protocol settings.
	One of the fixtures is defective and disturbs data transmission on the link.	Bypass one fixture at a time until normal operation is regained: unplug both connectors and connect them directly together. Have the defective fixture serviced by a qualified technician.
	XLR pin-out on fixtures does not match (pins 2 and 3 reversed).	Install a phase-reversing cable between the fixtures or swap pins 2 and 3 in the fixture that behaves erratically.
Magnetically indexed effect resets correctly but wanders after fixture reaches operating temperature.	Effect wheel or magnetic sensor requires mechanical adjustment.	Disable effects feedback. Contact Martin technician for service.
No light and "LERR" error message displayed.	The ballast and transformer settings do not match local AC voltage and frequency.	Disconnect fixture. Check ballast and transformer settings and correct if necessary.
	Lamp missing or blown	Disconnect fixture and replace lamp.
Lamp cuts out intermittently.	Fixture is too hot.	Allow fixture to cool. Reduce ambient room temperature. Recalibrate temperature sensors.
	The ballast and transformer settings do not match local AC voltage and frequency.	Check ballast and transformer settings and correct if necessary.

PCB layout

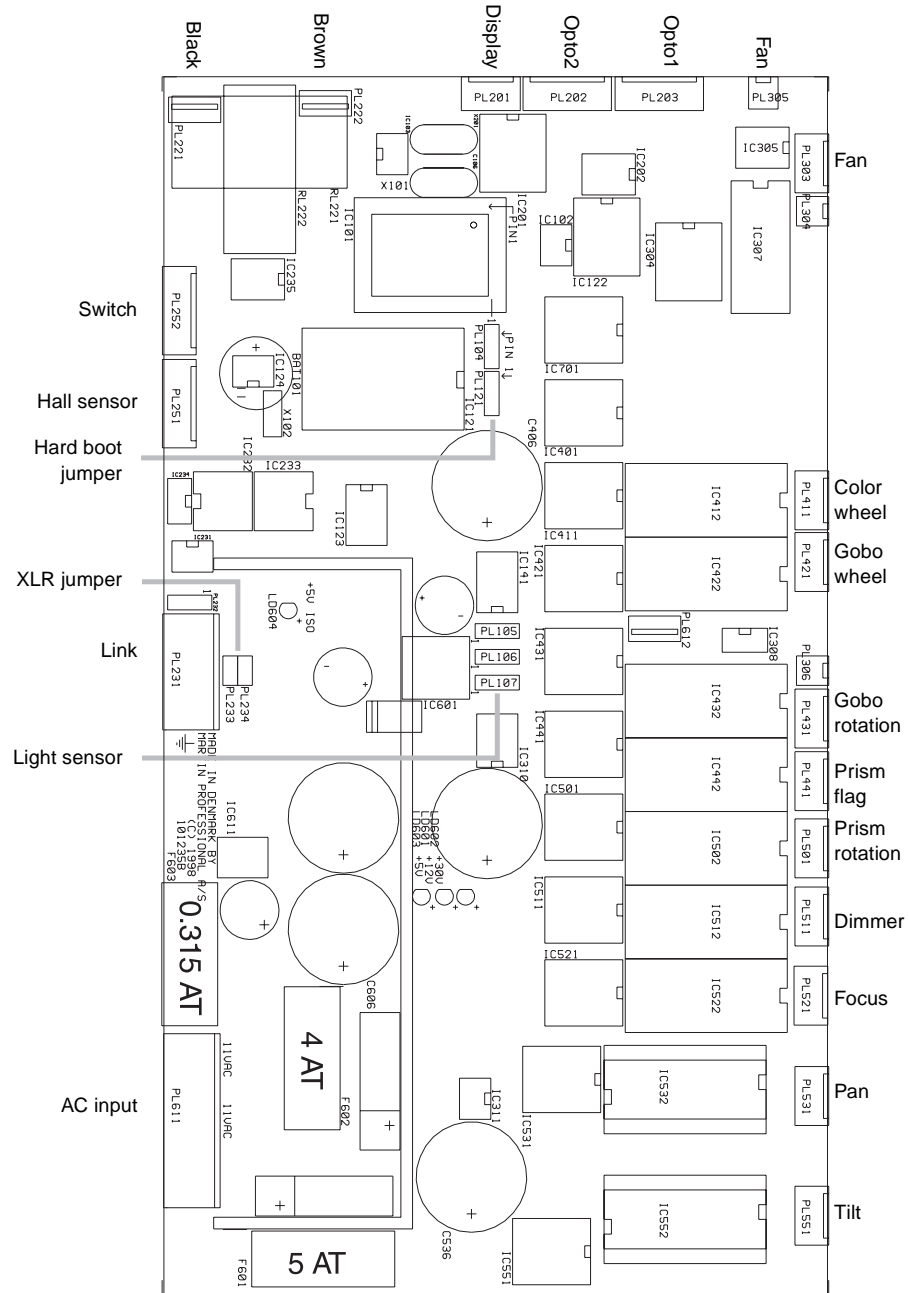

Specifications

Physical

- Length..... 330 mm (13.0 in)
- Width 384 mm (15.1 in)
- Maximum height (full tilt)..... 525 mm (20.7 in)
- Weight, *MAC 250* 21 kg (46.2 lbs)
- Weight, *MAC 250⁺*..... 22 kg (48.4 lbs)

Lamps

- Philips MSD 250/2 2000 hr, 6500K, 250 W, 72 lm/W
- Osram HSD 250 2000 hr, 6000K, 250 W, 68 lm/W

Performance

- Light output, *MAC 250* (17.5° configuration, diffuser installed) 3180 lumens
- Light output, *MAC 250⁺* (diffuser installed)..... 3180 lumens

Gobos

- Outside diameter..... 22.5 mm + 0/- 0.3 mm (0.886 in. +0/- 0.012 in)
- Maximum image diameter..... 17 mm (0.669 in)
- Maximum thickness..... 1.8 mm (0.071 in)
- Glass type high temperature Borofloat or better
- Glass coating dichroic or enhanced aluminum
- Metal..... aluminum (steel okay for short use)

Thermal

- Maximum ambient temperature (T_a) 40° C (104° F)
- Maximum surface temperature..... 110° C (230° F)

Control and programming

- Data pinout pin 1 shield, pin 2 cold (-), pin 3 hot (+)
- Receiver Opto-isolated RS-485
- Protocols USITT DMX-512 (1990), Martin RS-485
- DMX Channels..... 9 - 13

Connections

- AC input..... 3-prong IEC male socket
- Data input locking 3-pin XLR male socket
- Data output locking 3-pin XLR female socket

Fuses

- Fuse 01 (primary) 6.3 A / 250 V time-delay
- Fuse F601 5.0 A / 250 V time-delay
- Fuse F602 4.0 A / 250 V time-delay
- Fuse F603 0.315 A / 250 V time-delay

Design standards

- Canadian safety CSA C22.2 NO 166
- EU EMC EN 50 081-1, EN 50 082-1
- EU safety EN 60598-1, EN 60598-2-17
- US safety ANSI/UL 1573

Installation

- Orientation any
- Minimum distance to combustible materials..... 0.3 m (12 in)
- Minimum distance to illuminated surfaces..... 0.3 m (12 in)

Accessories

- Flight case, 4 x *MAC 250*..... 91510005
- Flight case, 2 x *MAC 250*..... 91510004
- MPBB1 Uploader 90758410
- G-clamp 91602003
- Half-coupler clamp..... 91602005

MAC 250 / MAC 250+ DMX Protocol

Start code = 0
Implemented from CPU software version 1.3

MODE																																																																													
		1	2	3	4																																																																								
L I G H T	1	closed				open				←				opening				closing				fast				med				slow				OPEN				RESET				OPEN				LAMP ON				OPEN				LAMP OFF																							
	2	closed																																																																											
C O L O R	3	CONTINUOUS COLOR SCROLL												STEPPED COLOR SCROLL												CONTINUOUS ROTATION				RND COLOR																																															
		white	C1	C2	C3	C4	C5	C6	C7	C8	C9	C10	C11	C12	12	11	10	9	8	7	6	5	4	3	2	1	*	0	cw	ccw	ccw	ccw	208	←	226	227	→	245	f	m	s																																				
G O B O	4	GOBO SELECTION								GOBO SHAKE								CONTINUOUS ROTATION																																																											
	MAC 250	open*	G1	G2	G3	G4	G5	G6	G7	G8	G8	G7	G6	G5	G4	G3	G2	G1	210	→	232	233	←	255	cw	ccw																																																			
	MAC 250+	0*	1	2	3	4	5	6	7	8	0*	1	2	3	4	5	6	7	8	G8	G7	G6	G5	G4	G3	G2	G1	210	→	232	233	←	255	cw	ccw																																										
5	GOBO ROTATION																CONTINUOUS ROTATION																																																												
	0°	indexing (MAC 250+ only)																395°																																																											
	st 3	continuous cw rotation →																← continuous ccw rotation																																																											
		127 128																252 st																																																											
F O C U S	6	infinity																																																																											
	7	PRISM												MACROS																																																															
	0	out				cw rotation				stop*				ccw rotation				out				1				2				3				4				5				6				7				8																											
		19				20				←				79				80				89				90				→				149				150				215				216				221				226				231				236				241				246				251			
P A N / T I L T	8	left																																																																											
	- 9	PAN																																																																											
	- 9	left																																																																											
	9	PAN FINE (LSB)																																																																											
10	up																																																																												
10	TILT																																																																												
- 11	down																																																																												
- 11	up																																																																												
10	TILT FINE (LSB)																																																																												
12	PAN/TILT SPEED																																																																												
12	T 3	fast																							slow		245	T _s	T _r	↔																																															
S P E E D	11	T 3	EFFECTS SPEED																							* Set ch. 3, 4, and 7 to value marked to override disabled function.																																																			
		T 3	dimmer, focus																							←				T = tracking mode (0-2 & 246-251)																																															
		T 3	colors																							←				245 T _s T _r ↔																																															
		T 3	gobo indexing (MAC 250+)																							←				S = normal PTSP / shortcuts off (Overrides personality setting)																																															
	0	gobo selection																							no change				F = fast PTSP / shortcuts on (Overrides personality setting)																																																
	0	rotating prism																							no change				↔ = blackout speed (252-255)																																																
	0																								← = variable speed, points to fast				245 T _s F↔↔																																																
	0																												251 ↔																																																



**Unit C6, Hastingwood Trading Estate
35, Harbet Road, London, N18 3HU**

Phone 020 8803 7400
FAX 020 8803 5060

email office@gradav.co.uk
Web www.gradav.co.uk