



## PEAK (H50 - Ø70) design Aksu, Suardi



Tavolo basso

Anno di produzione: 2013

Versioni: standard, luminosa, laccata.

Materiali: Polietilene, vetro temperato.

Dimensioni: Ø 70 h 50 cm

Peso: 10 Kg

Imballaggio: 51 x 36 x 43

85 x 85 x 1 cm

Volume imballaggio: 0,086 m<sup>3</sup>

Table bas

Année de production: 2013

Versions: standard, lumineuse, laquée.

Matériaux: Polyéthylène, verre trempé.

Dimensions: Ø 70 h 50 cm

Poids: 10 Kg

Emballage: 51 x 36 x 43

85 x 85 x 1 cm

Volume emballage: 0,086 m<sup>3</sup>

Coffee table

Year of production: 2013

Versions: standard, lighting, lacquered.

Material: Polyethylene, tempered glass.

Dimensions: Ø 70 h 50 cm

Weight: 10 Kg

Packaging: 51 x 36 x 43

85 x 85 x 1 cm

Packaging volume: 0,086 m<sup>3</sup>

Nota: due scatole.

Note: deux boîtes.

Note: two boxes.

<b>DIMENSIONS (cm)</b>			
<b>CODE</b>	SD PEA050 standard	LP PEA050 lighting	SL PEA050 lacquered
	1x	1x	Energy saving bulb recommended (not included).
<b>COLOURS</b>	<b>STANDARD</b> ○ MILKY WHITE (code FT) ● JET BLACK (code FH) ● ELEPHANT GREY (code FG) ● CHOCOLATE BROWN (code FE) ● ARGIL GREY (code FJ) ● DOVE GREY (code FP) ● POWDER BLUE (code FL) ● MALVA GREEN (code FV) ● LIME GREEN (code FR) ● SAFFRON YELLOW (code FB) ● PUMPKIN ORANGE (code FC) ● FLAME RED (code FD) ● SWEET FUCHSIA (code FU)	<b>LIGHTING</b> ○ LIGHT WHITE (code LA)	<b>LACQUERED</b> (code GLOSSY/MATT) ○ ABSOLUTE WHITE (code QA/MF) ● GLAMOUR BLACK (code QH/MI) ● VANITY GREY (code QG/MK) ● CHARMING IVORY (code Q2/M3) ● SUPREME RED (code QD/MN) ● METALLIC GOLD (code QO/MZ) ● METALLIC SILVER (code QM/MY) ● METALLIC COPPER (code Q4/M5)



## PEAK (H50 - Ø80) design Aksu, Suardi



Tavolo basso

Anno di produzione: 2013

Versioni: standard, luminosa, laccata.

Materiali: Polietilene, vetro temperato.

Dimensioni: Ø 80 h 50 cm

Peso: 13 Kg

Imballaggio: 51 x 36 x 43

85 x 85 x 1 cm

Volume imballaggio: 0,341 m<sup>3</sup>

Table bas

Année de production: 2013

Versions: standard, lumineuse, laquée.

Matériaux: Polyéthylène, verre trempé.

Dimensions: Ø 80 h 50 cm

Poids: 13 Kg

Emballage: 51 x 36 x 43

85 x 85 x 1 cm

Volume emballage: 0,341 m<sup>3</sup>

Coffee table

Year of production: 2013

Versions: standard, lighting, lacquered.

Material: Polyethylene, tempered glass.

Dimensions: Ø 80 h 50 cm

Weight: 13 Kg

Packaging: 51 x 36 x 43

85 x 85 x 1 cm

Packaging volume: 0,341 m<sup>3</sup>

Nota: due scatole.

Note: deux boîtes.

Note: two boxes.

<b>DIMENSIONS (cm)</b>			
<b>CODE</b>	SD PEA051 standard	LP PEA051 lighting	SL PEA051 lacquered
<b>COLOURS</b>	<b>STANDARD</b> <ul style="list-style-type: none"> <li>○ MILKY WHITE (code FT)</li> <li>● JET BLACK (code FH)</li> <li>● ELEPHANT GREY (code FG)</li> <li>● CHOCOLATE BROWN (code FE)</li> <li>● ARGIL GREY (code FJ)</li> <li>● DOVE GREY (code FP)</li> <li>● POWDER BLUE (code FL)</li> <li>● MALVA GREEN (code FV)</li> <li>● LIME GREEN (code FR)</li> <li>● SAFFRON YELLOW (code FB)</li> <li>● PUMPKIN ORANGE (code FC)</li> <li>● FLAME RED (code FD)</li> <li>● SWEET FUCHSIA (code FU)</li> </ul>	<b>LIGHTING</b> <ul style="list-style-type: none"> <li>○ LIGHT WHITE (code LA)</li> </ul>	<b>LACQUERED</b> (code GLOSSY/MATT) <ul style="list-style-type: none"> <li>○ ABSOLUTE WHITE (code QA/MF)</li> <li>● GLAMOUR BLACK (code QH/MI)</li> <li>● VANITY GREY (code QG/MK)</li> <li>● CHARMING IVORY (code Q2/M3)</li> <li>● SUPREME RED (code QD/MN)</li> <li>● METALLIC GOLD (code QO/MZ)</li> <li>● METALLIC SILVER (code QM/MY)</li> <li>● METALLIC COPPER (code Q4/M5)</li> </ul>
<b>Lighting</b>	1x	Energy saving bulb recommended (not included).	



## PEAK (H80 - Ø70) design Aksu, Suardi



Tavolo

Anno di produzione: 2010

Versioni: standard, luminosa, laccata.

Materiali: Polietilene, vetro temperato.

Dimensioni: Ø 70 h 80 cm

Peso: 12 Kg

Imballaggio: 50 x 50 x 84 cm

85 x 85 x 1 cm

Volume imballaggio: 0,217 m<sup>3</sup>

Table

Année de production: 2010

Versions: standard, lumineuse, laquée.

Matériaux: Polyéthylène, verre trempé.

Dimensions: Ø 70 h 80 cm

Poids: 12 Kg

Emballage: 50 x 50 x 84 cm

85 x 85 x 1 cm

Volume emballage: 0,217 m<sup>3</sup>

Table

Year of production: 2010

Versions: standard, lighting, lacquered.

Material: Polyethylene, tempered glass.

Dimensions: Ø 70 h 80 cm

Weight: 12 Kg

Packaging: 50 x 50 x 84 cm

85 x 85 x 1 cm

Packaging volume: 217 m<sup>3</sup>

Nota: due scatole.

Note: deux boîtes.

Note: two boxes.

<b>DIMENSIONS (cm)</b>			
<b>CODE</b>	SD PEA080 standard	LP PEA080 lighting	SL PEA080 lacquered
	1x	1x  Energy saving bulb recommended (not included).	
<b>COLOURS</b>	<b>STANDARD</b> <ul style="list-style-type: none"> <li>○ MILKY WHITE (code FT)</li> <li>● JET BLACK (code FH)</li> <li>● ELEPHANT GREY (code FG)</li> <li>● CHOCOLATE BROWN (code FE)</li> <li>● ARGIL GREY (code FJ)</li> <li>● DOVE GREY (code FP)</li> <li>● POWDER BLUE (code FL)</li> <li>● MALVA GREEN (code FV)</li> <li>● LIME GREEN (code FR)</li> <li>● SAFFRON YELLOW (code FB)</li> <li>● PUMPKIN ORANGE (code FC)</li> <li>● FLAME RED (code FD)</li> <li>● SWEET FUCHSIA (code FU)</li> </ul>	<b>LIGHTING</b> <ul style="list-style-type: none"> <li>○ LIGHT WHITE (code LA)</li> </ul>	<b>LACQUERED</b> (code GLOSSY/MATT) <ul style="list-style-type: none"> <li>○ ABSOLUTE WHITE (code QA/MF)</li> <li>● GLAMOUR BLACK (code QH/MI)</li> <li>● VANITY GREY (code QG/MK)</li> <li>● CHARMING IVORY (code Q2/M3)</li> <li>● SUPREME RED (code QD/MN)</li> <li>● METALLIC GOLD (code QO/MZ)</li> <li>● METALLIC SILVER (code QM/MY)</li> <li>● METALLIC COPPER (code Q4/M5)</li> </ul>



## PEAK (H80 - Ø80) design Aksu, Suardi



Tavolo

Anno di produzione: 2010

Versioni: standard, luminosa, laccata.

Materiali: Polietilene, vetro temperato.

Dimensioni: Ø 80 h 80 cm

Peso: 15 Kg

Imballaggio: 50 x 50 x 84 cm

85 x 85 x 1 cm

Volume imballaggio: 0,177 m<sup>3</sup>

Table

Année de production: 2010

Versions: standard, lumineuse, laquée.

Matériaux: Polyéthylène, verre trempé.

Dimensions: Ø 80 h 80 cm

Poids: 15 Kg

Emballage: 50 x 50 x 84 cm

85 x 85 x 1 cm

Volume emballage: 0,177 m<sup>3</sup>

Table

Year of production: 2010

Versions: standard, lighting, lacquered.

Material: Polyethylene, tempered glass.

Dimensions: Ø 80 h 80 cm

Weight: 15 Kg

Packaging: 50 x 50 x 84 cm

85 x 85 x 1 cm

Packaging volume: 0,177 m<sup>3</sup>

Nota: due scatole.

Note: deux boîtes.

Note: two boxes.

<b>DIMENSIONS (cm)</b>			
<b>CODE</b>	SD PEA081 standard SL PEA081 lacquered	LP PEA081 lighting	
<b>COLOURS</b>	1x <b>I3 MEDIUM</b>	1x <b>25W</b> Energy saving bulb recommended (not included).	STANDARD <ul style="list-style-type: none"> <li>○ MILKY WHITE (code FT)</li> <li>● JET BLACK (code FH)</li> <li>● ELEPHANT GREY (code FG)</li> <li>● CHOCOLATE BROWN (code FE)</li> <li>● ARGIL GREY (code FJ)</li> <li>● DOVE GREY (code FP)</li> <li>● POWDER BLUE (code FL)</li> <li>● MALVA GREEN (code FV)</li> <li>● LIME GREEN (code FR)</li> <li>● SAFFRON YELLOW (code FB)</li> <li>● PUMPKIN ORANGE (code FC)</li> <li>● FLAME RED (code FD)</li> <li>● SWEET FUCHSIA (code FU)</li> </ul>
		LIGHTING <ul style="list-style-type: none"> <li>○ LIGHT WHITE (code LA)</li> </ul>	LACQUERED (code GLOSSY/MATT) <ul style="list-style-type: none"> <li>○ ABSOLUTE WHITE (code QA/MF)</li> <li>● GLAMOUR BLACK (code QH/MI)</li> <li>● VANITY GREY (code QG/MK)</li> <li>● CHARMING IVORY (code Q2/M3)</li> <li>● SUPREME RED (code QD/MN)</li> <li>● METALLIC GOLD (code QO/MZ)</li> <li>● METALLIC SILVER (code QM/MY)</li> <li>● METALLIC COPPER (code Q4/M5)</li> </ul>



## PEAK (H120 - Ø70) design Aksu, Suardi



Tavolo alto  
 Anno di produzione: 2010  
 Versioni: standard, luminosa, laccata.  
 Materiali: Polietilene, vetro temperato.  
 Dimensioni: Ø 70 h 120 cm  
 Peso: 15 Kg  
 Imballaggio: 55 x 55 x 122 cm  
 85 x 85 x 1 cm  
 Volume imballaggio: 0,376 m<sup>3</sup>

Table haut  
 Année de production: 2010  
 Versions: standard, lumineuse, laquée.  
 Matériaux: Polyéthylène, verre trempé.  
 Dimensions: Ø 70 h 120 cm  
 Poids: 15 Kg  
 Emballage: 55 x 55 x 122 cm  
 85 x 85 x 1 cm  
 Volume emballage: 0,376 m<sup>3</sup>

High table  
 Year of production: 2010  
 Versions: standard, lighting, lacquered.  
 Material: Polyethylene, tempered glass.  
 Dimensions: Ø 70 h 120 cm  
 Weight: 15 Kg  
 Packaging: 55 x 55 x 122 cm  
 85 x 85 x 1 cm  
 Packaging volume: 0,376 m<sup>3</sup>

Nota: due scatole.

Note: deux boîtes.

Note: two boxes.

<b>DIMENSIONS (cm)</b>			
<b>CODE</b>	SD PEA120 standard	LP PEA120 lighting	SL PEA120 lacquered
	1x	1x	Energy saving bulb recommended (not included).
<b>COLOURS</b>	<b>STANDARD</b> <ul style="list-style-type: none"> <li>○ MILKY WHITE (code FT)</li> <li>● JET BLACK (code FH)</li> <li>● ELEPHANT GREY (code FG)</li> <li>● CHOCOLATE BROWN (code FE)</li> <li>● ARGIL GREY (code FJ)</li> <li>● DOVE GREY (code FP)</li> <li>● POWDER BLUE (code FL)</li> <li>● MALVA GREEN (code FV)</li> <li>● LIME GREEN (code FR)</li> <li>● SAFFRON YELLOW (code FB)</li> <li>● PUMPKIN ORANGE (code FC)</li> <li>● FLAME RED (code FD)</li> <li>● SWEET FUCHSIA (code FU)</li> </ul>	<b>LIGHTING</b> <ul style="list-style-type: none"> <li>○ LIGHT WHITE (code LA)</li> </ul>	<b>LACQUERED</b> (code GLOSSY/MATT) <ul style="list-style-type: none"> <li>○ ABSOLUTE WHITE (code QA/MF)</li> <li>● GLAMOUR BLACK (code QH/MI)</li> <li>● VANITY GREY (code QG/MK)</li> <li>● CHARMING IVORY (code Q2/M3)</li> <li>● SUPREME RED (code QD/MN)</li> <li>● METALLIC GOLD (code QO/MZ)</li> <li>● METALLIC SILVER (code QM/MY)</li> <li>● METALLIC COPPER (code Q4/M5)</li> </ul>



## PEAK (H120 - Ø80) design Aksu, Suardi



Tavolo alto  
 Anno di produzione: 2010  
 Versioni: standard, luminosa, laccata.  
 Materiali: Polietilene, vetro temperato.  
 Dimensioni: Ø 80 h 120 cm  
 Peso: 18 Kg  
 Imballaggio: 55 x 55 x 122 cm  
 85 x 85 x 1 cm  
 Volume imballaggio: 0,376 m<sup>3</sup>

Table haut  
 Année de production: 2010  
 Versions: standard, lumineuse, laquée.  
 Matériaux: Polyéthylène, verre trempé.  
 Dimensions: Ø 80 h 120 cm  
 Poids: 18 Kg  
 Emballage: 55 x 55 x 122 cm  
 85 x 85 x 1 cm  
 Volume emballage: 0,376 m<sup>3</sup>

High table  
 Year of production: 2010  
 Versions: standard, lighting, lacquered.  
 Material: Polyethylene, tempered glass.  
 Dimensions: Ø 80 h 120 cm  
 Weight: 18 Kg  
 Packaging: 55 x 55 x 122 cm  
 85 x 85 x 1 cm  
 Packaging volume: 0,376 m<sup>3</sup>

Nota: due scatole.

Note: deux boîtes.

Note: two boxes.

<b>DIMENSIONS (cm)</b>			
<b>CODE</b>	SD PEA121 standard	LP PEA121 lighting	SL PEA121 lacquered
	1x	Energy saving bulb recommended (not included).	
<b>COLOURS</b>	<b>STANDARD</b> <ul style="list-style-type: none"> <li>○ MILKY WHITE (code FT)</li> <li>● JET BLACK (code FH)</li> <li>● ELEPHANT GREY (code FG)</li> <li>● CHOCOLATE BROWN (code FE)</li> <li>● ARGIL GREY (code FJ)</li> <li>● DOVE GREY (code FP)</li> <li>● POWDER BLUE (code FL)</li> <li>● MALVA GREEN (code FV)</li> <li>● LIME GREEN (code FR)</li> <li>● SAFFRON YELLOW (code FB)</li> <li>● PUMPKIN ORANGE (code FC)</li> <li>● FLAME RED (code FD)</li> <li>● SWEET FUCHSIA (code FU)</li> </ul>	<b>LIGHTING</b> <ul style="list-style-type: none"> <li>○ LIGHT WHITE (code LA)</li> </ul>	<b>LACQUERED</b> (code GLOSSY/MATT) <ul style="list-style-type: none"> <li>○ ABSOLUTE WHITE (code QA/MF)</li> <li>● GLAMOUR BLACK (code QH/MI)</li> <li>● VANITY GREY (code QG/MK)</li> <li>● CHARMING IVORY (code Q2/M3)</li> <li>● SUPREME RED (code QD/MN)</li> <li>● METALLIC GOLD (code QO/MZ)</li> <li>● METALLIC SILVER (code QM/MY)</li> <li>● METALLIC COPPER (code Q4/M5)</li> </ul>



## PEAK (H50 - SQUARE GLASS 80) design Aksu, Suardi



Tavolo basso

Anno di produzione: 2013

Versioni: standard, luminosa, laccata.

Materiali: Polietilene, vetro temperato.

Dimensioni: 80 x 80 h 50 cm

Peso: 21 Kg

Imballaggio: 51 x 36 x 43 cm

85 x 85 x 1 cm

Volume imballaggio: 0,086 m<sup>3</sup>

Table bas

Année de production: 2013

Versions: standard, lumineuse, laquée.

Matériaux: Polyéthylène, verre trempé.

Dimensions: 80 x 80 h 50 cm

Poids: 21 Kg

Emballage: 51 x 36 x 43 cm

85 x 85 x 1 cm

Volume emballage: 0,086 m<sup>3</sup>

Coffee table

Year of production: 2013

Versions: standard, lighting, lacquered.

Material: Polyethylene, tempered glass.

Dimensions: 80 x 80 h 50 cm

Weight: 21 Kg

Packaging: 51 x 36 x 43 cm

85 x 85 x 1 cm

Packaging volume: 0,086 m<sup>3</sup>

Nota: due scatole.

Note: deux boîtes.

Note: two boxes.

<b>DIMENSIONS (cm)</b>				
<b>CODE</b>	SD PEA052 standard		LP PEA052 lighting	
	1x	1x  Energy saving bulb recommended (not included).		
<b>COLOURS</b>	<b>STANDARD</b> ○ MILKY WHITE (code FT) ● JET BLACK (code FH) ● ELEPHANT GREY (code FG) ● CHOCOLATE BROWN (code FE) ● ARGIL GREY (code FJ) ● DOVE GREY (code FP) ● POWDER BLUE (code FL) ● MALVA GREEN (code FV) ● LIME GREEN (code FR) ● SAFFRON YELLOW (code FB) ● PUMPKIN ORANGE (code FC) ● FLAME RED (code FD) ● SWEET FUCHSIA (code FU)	<b>LIGHTING</b> ○ LIGHT WHITE (code LA)	<b>LACQUERED</b> (code GLOSSY/MATT) ○ ABSOLUTE WHITE (code QA/MF) ● GLAMOUR BLACK (code QH/MI) ● VANITY GREY (code QG/MK) ● CHARMING IVORY (code Q2/M3) ● SUPREME RED (code QD/MN) ● METALLIC GOLD (code QO/MZ) ● METALLIC SILVER (code QM/MY) ● METALLIC COPPER (code Q4/M5)	



## PEAK (H80 - SQUARE GLASS 80) design Aksu, Suardi



Tavolo

Anno di produzione: 2012

Versioni: luminosa, laccata.

Materiali: Polietilene, vetro temperato.

Dimensioni: 80 x 80 h 80 cm

Peso: 24 Kg

Imballaggio: 50 x 50 x 84 cm

85 x 85 x 1 cm

Volume imballaggio: 0,217 m<sup>3</sup>

Table

Année de production: 2012

Versions: lumineuse, laquée.

Matériaux: Polyéthylène, verre trempé.

Dimensions: 80 x 80 h 80 cm

Poids: 24 Kg

Emballage: 50 x 50 x 84 cm

85 x 85 x 1 cm

Volume emballage: 0,217 m<sup>3</sup>

Table

Year of production: 2012

Versions: lighting, lacquered.

Material: Polyethylene, tempered glass.

Dimensions: 80 x 80 h 80 cm

Weight: 24 Kg

Packaging: 50 x 50 x 84 cm

85 x 85 x 1 cm

Packaging volume: 0,217 m<sup>3</sup>

Nota: due scatole.

Note: deux boîtes.

Note: two boxes.

<b>DIMENSIONS (cm)</b>			
<b>CODE</b>	SD PEA082 standard	LP PEA082 lighting	SL PEA082 lacquered
	1x	Energy saving bulb recommended (not included).	
<b>COLOURS</b>	<b>STANDARD</b> <ul style="list-style-type: none"> <li>○ MILKY WHITE (code FT)</li> <li>● JET BLACK (code FH)</li> <li>● ELEPHANT GREY (code FG)</li> <li>● CHOCOLATE BROWN (code FE)</li> <li>● ARGIL GREY (code FJ)</li> <li>● DOVE GREY (code FP)</li> <li>● POWDER BLUE (code FL)</li> <li>● MALVA GREEN (code FV)</li> <li>● LIME GREEN (code FR)</li> <li>● SAFFRON YELLOW (code FB)</li> <li>● PUMPKIN ORANGE (code FC)</li> <li>● FLAME RED (code FD)</li> <li>● SWEET FUCHSIA (code FU)</li> </ul>	<b>LIGHTING</b> <ul style="list-style-type: none"> <li>○ LIGHT WHITE (code LA)</li> </ul>	<b>LACQUERED (code GLOSSY/MATT)</b> <ul style="list-style-type: none"> <li>○ ABSOLUTE WHITE (code QA/MF)</li> <li>● GLAMOUR BLACK (code QH/MI)</li> <li>● VANITY GREY (code QG/MK)</li> <li>● CHARMING IVORY (code Q2/M3)</li> <li>● SUPREME RED (code QD/MN)</li> <li>● METALLIC GOLD (code QO/MZ)</li> <li>● METALLIC SILVER (code QM/MY)</li> <li>● METALLIC COPPER (code Q4/M5)</li> </ul>





## PEAK (H120 - SQUARE GLASS 80) design Aksu, Suardi



Tavolo alto

Anno di produzione: 2012

Versioni: standard, luminosa, laccata.

Materiali: Polietilene, vetro temperato.

Dimensioni: 80 x 80 h 120 cm

Peso: 27 Kg

Imballaggio: 55 x 55 x 122 cm

85 x 85 x 1 cm

Volume imballaggio: 0,376 m<sup>3</sup>

Table haut

Année de production: 2012

Versions: standard, lumineuse, laquée.

Matériaux: Polyéthylène, verre trempé.

Dimensions: 80 x 80 h 120 cm

Poids: 27 Kg

Emballage: 55 x 55 x 122 cm

85 x 85 x 1 cm

Volume emballage: 0,376 m<sup>3</sup>

High table

Year of production: 2012

Versions: standard, lighting, lacquered.

Material: Polyethylene, tempered glass.

Dimensions: 80 x 80 h 120 cm

Weight: 27 Kg

Packaging: 55 x 55 x 122 cm

85 x 85 x 1 cm

Packaging volume: 0,376 m<sup>3</sup>

Nota: due scatole.

Note: deux boîtes.

Note: two boxes.

<b>DIMENSIONS (cm)</b>			
<b>CODE</b>	SD PEA122 standard		LP PEA122 lighting
<b>COLOURS</b>	SL PEA122 lacquered		1x  Energy saving bulb recommended (not included).
<b>COLOURS</b>	<b>STANDARD</b> ○ MILKY WHITE (code FT) ● JET BLACK (code FH) ● ELEPHANT GREY (code FG) ● CHOCOLATE BROWN (code FE) ● ARGIL GREY (code FJ) ● DOVE GREY (code FP) ● POWDER BLUE (code FL) ● MALVA GREEN (code FV) ● LIME GREEN (code FR) ● SAFFRON YELLOW (code FB) ● PUMPKIN ORANGE (code FC) ● FLAME RED (code FD) ● SWEET FUCHSIA (code FU)	<b>LIGHTING</b> ○ LIGHT WHITE (code LA)	<b>LACQUERED</b> (code GLOSSY/MATT) ○ ABSOLUTE WHITE (code QA/MF) ● GLAMOUR BLACK (code QH/MI) ● VANITY GREY (code QG/MK) ● CHARMING IVORY (code Q2/M3) ● SUPREME RED (code QD/MN) ● METALLIC GOLD (code QO/MZ) ● METALLIC SILVER (code QM/MY) ● METALLIC COPPER (code Q4/M5)



## PEAK (H80 - DOUBLE) design Aksu, Suardi



Tavolo

Anno di produzione: 2012

Versioni: standard, luminosa, laccata.

Materiali: Polietilene, vetro temperato.

Dimensioni: 180 x 80 h 80 cm

Peso: 52 Kg

Imballaggio: 50 x 50 x 84 cm (x2)

181 x 81 x 1 cm

Volume imballaggio: 0,450 m<sup>3</sup>

Table

Année de production: 2012

Versions: standard, lumineuse, laquée.

Matériaux: Polyéthylène, verre trempé.

Dimensions: 180 x 80 h 80 cm

Poids: 52 Kg

Emballage: 50 x 50 x 84 cm (x2)

181 x 81 x 1 cm

Volume emballage: 0,450 m<sup>3</sup>

Table

Year of production: 2012

Versions: standard, lighting, lacquered.

Material: Polyethylene, tempered glass.

Dimensions: 180 x 80 h 80 cm

Weight: 52 Kg

Packaging: 50 x 50 x 84 cm (x2)

181 x 81 x 1 cm

Packaging volume: 0,450 m<sup>3</sup>

Nota: tre scatole.

Note: trois boîtes.

Note: three boxes.

DIMENSIONS (cm)			
CODE	SD PEA220 standard	LP PEA220 lighting	SL PEA220 lacquered
COLOURS	<b>STANDARD</b> <ul style="list-style-type: none"> <li>○ MILKY WHITE (code FT)</li> <li>● JET BLACK (code FH)</li> <li>● ELEPHANT GREY (code FG)</li> <li>● CHOCOLATE BROWN (code FE)</li> <li>● ARGIL GREY (code FJ)</li> <li>● DOVE GREY (code FP)</li> <li>● POWDER BLUE (code FL)</li> <li>● MALVA GREEN (code FV)</li> <li>● LIME GREEN (code FR)</li> <li>● SAFFRON YELLOW (code FB)</li> <li>● PUMPKIN ORANGE (code FC)</li> <li>● FLAME RED (code FD)</li> <li>● SWEET FUCHSIA (code FU)</li> </ul>	<b>LIGHTING</b> <ul style="list-style-type: none"> <li>○ LIGHT WHITE (code LA)</li> </ul>	<b>LACQUERED</b> (code GLOSSY/MATT) <ul style="list-style-type: none"> <li>○ ABSOLUTE WHITE (code QA/MF)</li> <li>● GLAMOUR BLACK (code QH/MI)</li> <li>● VANITY GREY (code QG/MK)</li> <li>● CHARMING IVORY (code Q2/M3)</li> <li>● SUPREME RED (code QD/MN)</li> <li>● METALLIC GOLD (code QO/MZ)</li> <li>● METALLIC SILVER (code QM/MY)</li> <li>● METALLIC COPPER (code Q4/M5)</li> </ul>
	2x <b>13 MEDIUM</b>	2x <b>25W</b>	Energy saving bulb recommended (not included).



## PEAK (H120 - DOUBLE) design Aksu, Suardi



Tavolo alto

Anno di produzione: 2012

Versioni: standard, luminosa, laccata.

Materiali: Polietilene, vetro temperato.

Dimensioni: 180 x 80 h 120 cm

Peso: 58 Kg

Imballaggio: 55 x 55 x 122 cm (x2)

181 x 85 x 1 cm

Volume imballaggio: 0,753 m<sup>3</sup>

Table haut

Année de production: 2012

Versions: standard, lumineuse, laquée.

Matériaux: Polyéthylène, verre trempé.

Dimensions: 180 x 80 h 120 cm

Poids: 58 Kg

Emballage: 55 x 55 x 122 cm (x2)

181 x 85 x 1 cm

Volume emballage: 0,753 m<sup>3</sup>

High table

Year of production: 2012

Versions: standard, lighting, lacquered.

Material: Polyethylene, tempered glass.

Dimensions: 180 x 80 h 120 cm

Weight: 58 Kg

Packaging: 55 x 55 x 122 cm (x2)

181 x 85 x 1 cm

Packaging volume: 0,753 m<sup>3</sup>

Nota: tre scatole.

Note: trois boîtes.

Note: three boxes.

<b>DIMENSIONS (cm)</b>			
<b>CODE</b>	SL PEA221 lacquered	LP PEA221 lighting	
	2x <b>I3 MEDIUM</b>	2x <b>25W</b>	Energy saving bulb recommended (not included).
<b>COLOURS</b>	<b>STANDARD</b> <ul style="list-style-type: none"> <li>○ MILKY WHITE (code FT)</li> <li>● JET BLACK (code FH)</li> <li>● ELEPHANT GREY (code FG)</li> <li>● CHOCOLATE BROWN (code FE)</li> <li>● ARGIL GREY (code FJ)</li> <li>● DOVE GREY (code FP)</li> <li>● POWDER BLUE (code FL)</li> <li>● MALVA GREEN (code FV)</li> <li>● LIME GREEN (code FR)</li> <li>● SAFFRON YELLOW (code FB)</li> <li>● PUMPKIN ORANGE (code FC)</li> <li>● FLAME RED (code FD)</li> <li>● SWEET FUCHSIA (code FU)</li> </ul>	<b>LIGHTING</b> <ul style="list-style-type: none"> <li>○ LIGHT WHITE (code LA)</li> </ul>	<b>LACQUERED</b> (code GLOSSY/MATT) <ul style="list-style-type: none"> <li>○ ABSOLUTE WHITE (code QA/MF)</li> <li>● GLAMOUR BLACK (code QH/MI)</li> <li>● VANITY GREY (code QG/MK)</li> <li>● CHARMING IVORY (code Q2/M3)</li> <li>● SUPREME RED (code QD/MN)</li> <li>● METALLIC GOLD (code QO/MZ)</li> <li>● METALLIC SILVER (code QM/MY)</li> <li>● METALLIC COPPER (code Q4/M5)</li> </ul>



## PEAK ACCESSORIES



### ICE BUCKET

Material: PVC.  
Dimensions: Ø 23 h 23 cm

SD PEA001

COLOURS



SMOKED GREY

Note: The transparent white version is no longer available.

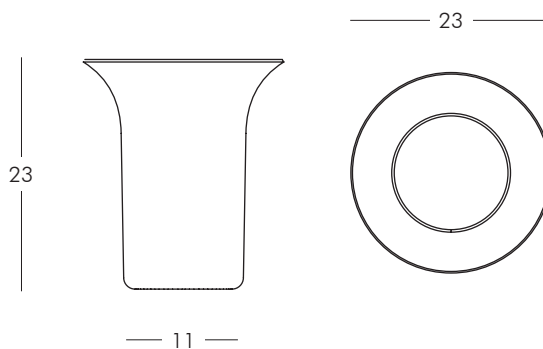

DIMENSIONS (cm) - CODE - COLOURS

### ASHTRAY

Material: metal.  
Dimensions: Ø 16 h 3,5 cm

SD PEA002

COLOURS ○ SIGNAL WHITE

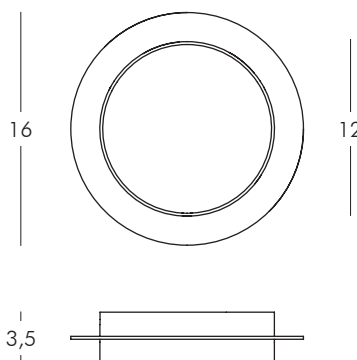
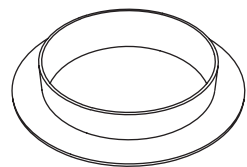

### BAG HOOK







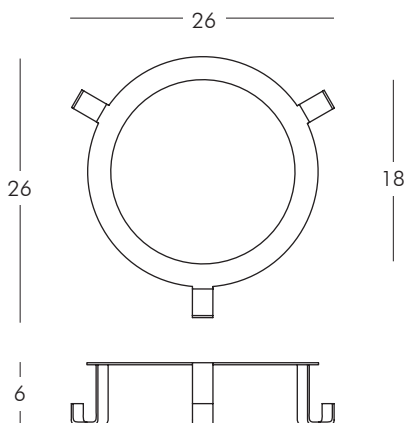
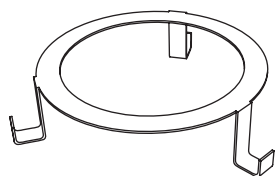

Material: metal.  
Dimensions: 26 x 26 h 6 cm

SD PEA003























COLOURS ○ SIGNAL WHITE





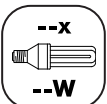

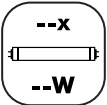
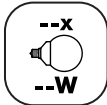

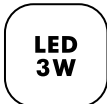

## SYMBOLS

 For indoor use.	 Stackable item.	 Conformity to the European Community instructions.
 For indoor and outdoor use.	 100% recyclable polyethylene.	 Recycling and disposal of electronic waste (WEEE).
 Outdoor version on request (IP55).	 European Community registered model.	

## LIGHTING SYMBOLS

 Protected against the intrusion of solid objects $\varnothing > 12$ mm, not against water.	 Standard lamp base for E27 - 27 mm light bulb.	 RGB lighting system.
 Protected against the intrusion of solid objects $\varnothing > 1$ mm and splashing water.	 Lamp base for G4 halogen bulb.	 Item compatible with Candy Light.
 Protected against the intrusion of dust and water jets.	 Lamp base for GU10 spotlight.	 Insulation class 1.
 Fully protected against the intrusion of dust and immersion in water.	 Lamp base for G13 neon tube.	 Insulation class 2.
 Small lamp base for E14 - 14 mm light bulb.	 Neon tube lighting system.	 Insulation class 3.
 Medium lamp base for E26 - 26 mm light bulb.	 LED technology lighting system.	 Device proper to direct assembly onto normally inflammable surfaces.
 Lighting through energy saving bulb. The upper figure shows the number of allowed bulbs. The lower figure shows the MAXIMUM recommended power.	 Lighting through energy saving fluorescent spotlight. The upper figure shows the number of allowed spotlights. The lower figure shows the MAXIMUM recommended power.	
 Lighting through neon tube. The upper figure shows the number of allowed neon tubes. The lower figure shows the MAXIMUM recommended power.	 Lighting through energy saving globe bulb. The upper figure shows the number of allowed bulbs. The lower figure shows the MAXIMUM recommended power.	
 Lighting through flexible LED tube. The lower figure shows the MAXIMUM recommended power.	 Lighting through circular T9 neon tube. The upper figure shows the number of allowed neon tubes. The lower figure shows the MAXIMUM recommended power.	

## WIRING SYMBOLS

 Wiring with metal clamp. IP20 protection. Diameter 11 cm.	 Wiring with special base for KIT LED 3 WATT. IP55 protection. Diameter 11,6 cm.
 Wiring with metal base. IP55 protection. Diameter 10 cm. Fastening by hex screw key.	 Wiring with plastic screw base. I3 - IP20 protection. E3 - IP55 protection. Diameter 6 cm.
 Wiring with metal base. IP55 protection. Diameter 20 cm. Fastening by hex screw key.	 Wiring with plastic screw base. I3 - IP20 protection. E3 - IP55 protection. Diameter 10 cm.
 Wiring with plastic base and metal inserts. I2 - IP20 protection. E2 - IP55 protection. Diameter 10 cm. Fastening by slot screwdriver.	 Wiring with plastic screw base. I3 - IP20 protection. E3 - IP55 protection. Diameter 15 cm.
 Wiring with plastic base and LED CANDY LIGHT. IP44 protection. Diameter 10 cm.	 Special metal base. IP20 protection. Several sizes.

## MATERIAL PROPERTIES

---

Material: Linear low-density polyethylene - LLDPE.

Production process: rotational moulding.

Resistant to extreme temperatures (-60°C to +80°C).

UV resistant (except for lighting colours).

High tensile strength.

## WARNING

---

- Keep away from excessive heat sources.
- Avoid any improper use. Do not stand on the products. When the product has to be moved, lift the product off the ground in order to avoid damage.
- Do not overload the pot structure in order to avoid deforming.
- Carefully comply with the maintenance & cleaning instructions.
- In case of malfunctioning or damage of the wiring or any electrical parts, refer to a qualified electrician.

## MAINTENANCE & CLEANING

---

- To prevent dust and dirt from sticking to the plastic surfaces, periodically clean the products with a damp cloth and neutral liquid soap diluted in water.
- Avoid using ethanol or any liquids containing, even in small amounts, acetone, trichloroethylene or ammonia (solvents in general).
- It is recommended the use of SLIDE's "CleanUp" cleaner or a degreaser. Spray the cleaning product on the surface, rub with a damp cloth and rinse abundantly with water (preferably with a high pressure washer). In case of persistent stains use a high pressure washer or scrub eraser. The use of the scrub eraser (melamine foam - Scotch-Brite® Easy Eraser or similar) is only recommended for white colour, as they are slightly abrasive.
- The lacquered version is also suitable for outdoor use, however it is more sensitive to scratches: periodically clean with a polish cleaner, gently rubbing with soft cloth/cotton wool.
- Cushions can be cleaned with a damp cloth, neutral liquid soap and water.
- For metal parts use specific cleaners.

## SUSTAINABILITY & RECYCLING

---

All SLIDE products are 100% recyclable. Furthermore, grey, black and chocolate matt colours are produced with recycled polyethylene. SLIDE has a closed production cycle with no health prejudicial emissions and complying with ecological sustainability rules.

When a product reaches the end of its life, do not treat the product or any of its parts as domestic waste. Dispose by sending to differentiated collection centres.

## RESPONSIBILITY & RETURNS

---

SLIDE declines any liability to damages caused to things or persons by an illegitimate use of the product. SLIDE won't accept any returned goods without having checked the kind of defects first.

## WARRANTY

---

SLIDE products are guaranteed against all manufacturing faults, granted that the items are appropriately used, for twenty-four (24) months from the date of purchase upon presentation of the invoice.

LED KITS only are guaranteed for twelve (12) months from the date of purchase.

Warranty doesn't include parts that are subject to wear and tear due to usage, batteries when provided, wiring and electrical parts that do not have manufacturing faults.



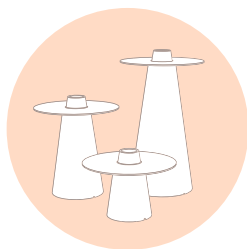

Certifies the conformity of the product to the European Community instructions.  
Certifica la conformità del prodotto alle disposizioni delle direttive comunitarie.  
Atteste la conformité du produit aux dispositions des directives communautaires.



Appliance suitable for installation on normally inflammable surfaces.  
Apparecchio idoneo ad essere installato su superfici normalmente infiammabili.  
L'appareil peut être installé sur des surfaces normalement inflammables.



Class 2: appliance fitted with double insulation, without ground connection.  
Classe 2: apparecchio con doppio isolamento, non richiede messa a terra.  
Classe 2: appareil à double isolation, ne nécessite pas de mise à la terre.



Appliance for indoor use only.  
Apparecchio per solo uso interno.  
Appareil pour usage interne uniquement.



**EN** - Warning: the safety of this fixture is only guaranteed if the following instructions have been observed. Always consult the technical sheet of the product on the [www.slidedesign.it](http://www.slidedesign.it) website.

- Before any operation on the fixture, please disconnect the power supply.
- Assembly and maintenance of the fixture must be performed carefully so components are not damaged.
- Replacement bulbs must be the same type and wattage as specified in the technical sheet. Use energy saving bulbs only.
- In case of damage to the feeding cable, please contact a SLIDE dealer or qualified personnel for replacement.
- Keep away from excessive heat sources.
- Avoid any improper use. Do not stand on the products. When the product has to be moved, lift the product off the ground in order to avoid damages.



**IT** - Attenzione: la sicurezza dell'apparecchio è garantita con l'uso appropriato delle seguenti istruzioni, pertanto è necessario conservarle. Consultare la scheda tecnica del prodotto sul sito [www.slidedesign.it](http://www.slidedesign.it).

- Prima di ogni operazione sull'apparecchio, disinserire la tensione di rete.
- Le operazioni di montaggio o manutenzione devono essere eseguite con la massima attenzione per non danneggiare i componenti.
- L'eventuale sostituzione della lampadina deve essere fatta con una dello stesso tipo e potenza massima indicata nella scheda tecnica. Si raccomanda l'uso esclusivo di lampadine a basso consumo energetico.
- In caso di danneggiamento del cavo di alimentazione, per la sostituzione contattare un rivenditore SLIDE o personale qualificato.
- Evitare di posizionare il prodotto in prossimità di fonti di calore eccessive.
- Evitare usi impropri e non consoni del prodotto. Non salire con i piedi sul prodotto. In caso di spostamento, sollevare il prodotto onde evitare danni ai componenti che appoggiano a terra.



**FR** - Attention: la sûreté de l'appareil n'est garantie qu'en suivant scrupuleusement les instructions ci-après. Il est donc nécessaire de les garder. Toujours consulter la fiche technique du produit sur le site [www.slidedesign.it](http://www.slidedesign.it).

- Avant toute opération sur l'appareil déconnecter l'alimentation électrique.
- Le montage et les manipulations de l'appareil devront être exécutés avec la plus grande attention pour ne pas abîmer ses composants.
- Tout changement d'ampoule respectera le type et la puissance indiqués dans la fiche technique. Il est recommandé de n'utiliser que des ampoules à basse consommation d'énergie.
- En cas d'endommagement du câble d'alimentation, et en vue de son remplacement, contactez votre revendeur SLIDE ou une personne dûment habilitée.
- Éviter de placer le produit à proximité de sources de chaleur excessive.
- Éviter l'utilisation inappropriée du produit. Ne pas monter sur les produits. Lorsque le produit doit être déplacé, soulever le produit afin d'éviter tout dommage.

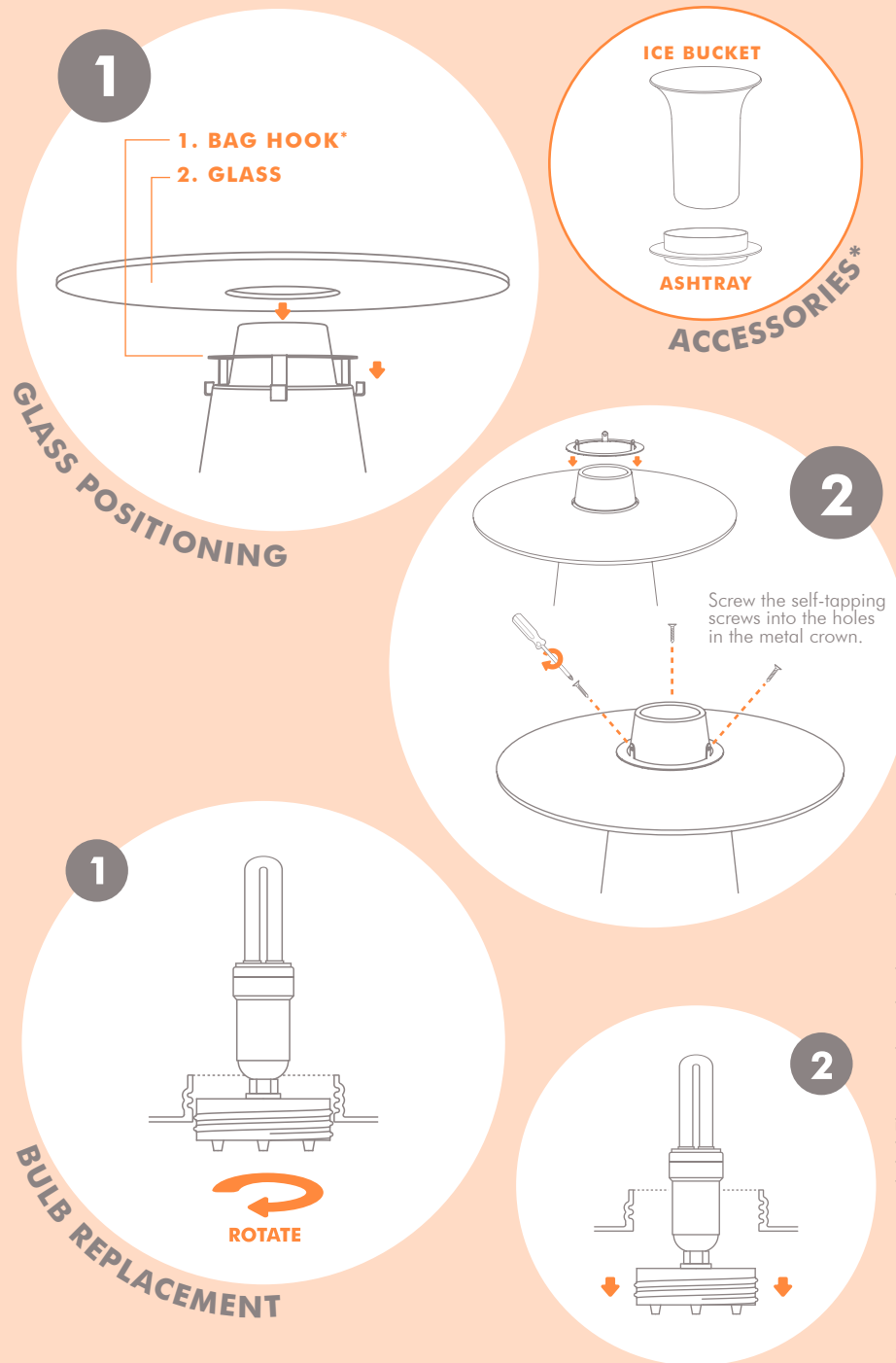

\*Accessories are not included. They must be ordered separately.